

**Best for evaluation of high-precision electronic components by wide source range and 6½-digit measurement resolution**

- Source and measurement range  
Voltage: 0 to ±110 V, Current: 0 to ±2 A
- 5½ source digits and 6½ measurement digits  
(Measurement resolution: 100 nV/1 pA)
- High-speed pulse source with the minimum pulse width of 25 μs
- Variable slew rate function: 10.0 V/s to 99.9 kV/s
- Variable integration function
- Sink-enabled bipolar output



**GPIB USB RS232 LAN**   
 Factory option    Factory option



**ADCMT 6253 DC Voltage Current Source / Monitor**

IM +3.200000μA  
 VM +110.0000 V  
 VS +110.000 V  
 HL +3.2000μA  
 LL -3.2000μA  
 Tr: 25.000ms  
 Tp: 50.000ms  
 IT-PLC MeasRng: FIX (SW) SrcRng: 100V RemSens: 2W

DATA ENTRY  
 7 8 9  
 4 5 6  
 1 2 3  
 0 +/-

TRIGGER    OUTPUT  
 TRIG HOLD    OPR STBY  
 SWP STOP    SUSPEND

DRIVING GUARD SENSE    OUTPUT  
 32V / 2A    110V PK    3V PK    HI  
 64V / 1A    110V PK    3V PK    LO  
 110V / 0.5A    500V MAX    3V PK    500V MAX



# High-resolution and high-throughput source monitor with 5½ source digits and 6½ measurement digits

The DC voltage current source/monitor 6253 can be widely used as power supply for evaluating semiconductors and electronic components in research and development and as power supply for characteristic evaluation systems.

In addition to high-accuracy, high-stability and low-noise performances of our strengths, the 6253 realizes higher precision features such as 5½-digit source resolution, 6½-digit measurement resolution and basic accuracy of ±0.02 %.

Furthermore, the 6253 can support various applications by the sweep functions, high-speed pulse measurement function with a minimum pulse width of 25 μs, the variable integration function and the newly adopted variable slew rate function.

USB and GPIB interfaces are mounted as standard, and LAN and RS232 interfaces are available optionally.

## Output Range .....

- Source and measurement range
  - ±2 A at ±32 V
  - ±1 A at ±64 V
  - ±0.5 A at ±110 V
- Sink-enabled bipolar output

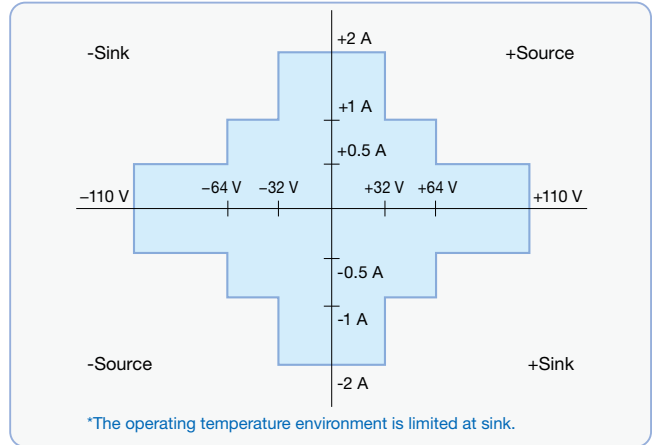

## Source and Measurement Functions .....

Voltage source (VS), current source (IS), voltage measurement (VM), current measurement (IM) and resistance measurement (RM) can be selected by specifying the source and measurement functions. The 6253 is equipped with A/D twin converters, allowing parallel measurement of voltage and current.

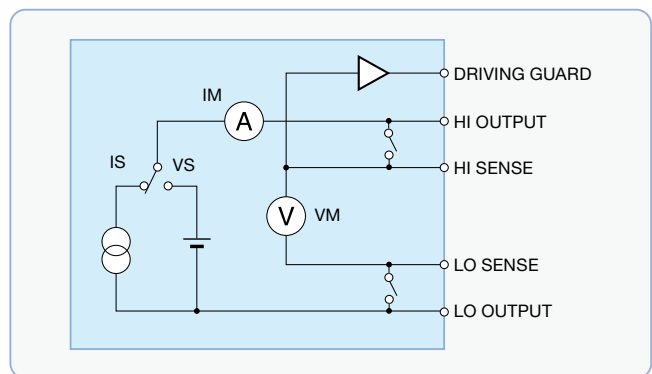

## Display Screen .....



Source voltage (VS), source current (IS), limit values (HL/LL), measured voltage (VM) and measurement current (IM) are displayed. Voltage and current can be measured simultaneously.

## Time Setting Screen .....



Time settings are important for pulse or sweep source. The time setting screen on the 6253 allows you to make these settings easier than the former models.

## Graph Display Screen .....

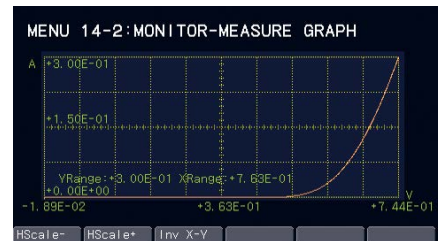

You can easily view measurement results from the graphically displayed measurement memory data.

There are two display options: voltage and current value display and display of the number of memories and measured values.

## Voltage/Current Source Mode

There are four voltage or current source modes: DC, pulse, DC sweep, pulse sweep. Then, the sweep modes are classified into five sweep types: fixed sweep, linear sweep, log sweep, random sweep (arbitrary waveform generation by user programming), multi-slope linear sweep (linear sweep with four selectable step values).

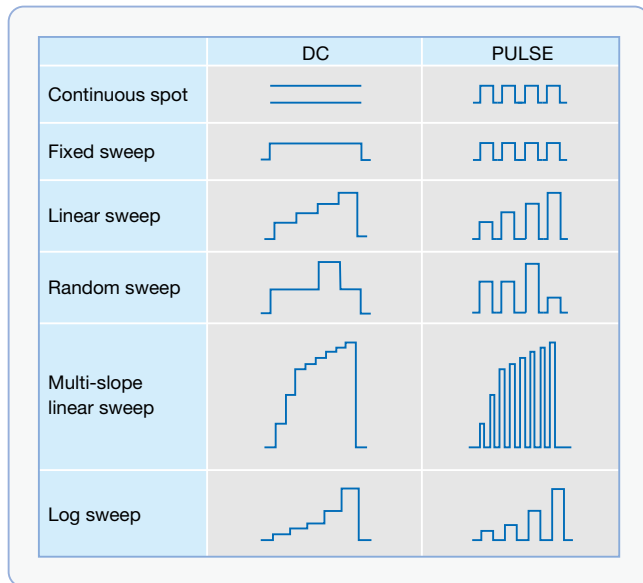

## Variable Slew Rate (SR) Function

The rising time and the falling time can be set freely in four ranges.  
(Variable slew rate)  
10.0 to 99.9 V/s, 100 to 999 V/s  
1.00 to 9.99 kV/s, 10.0 to 99.9 kV/s

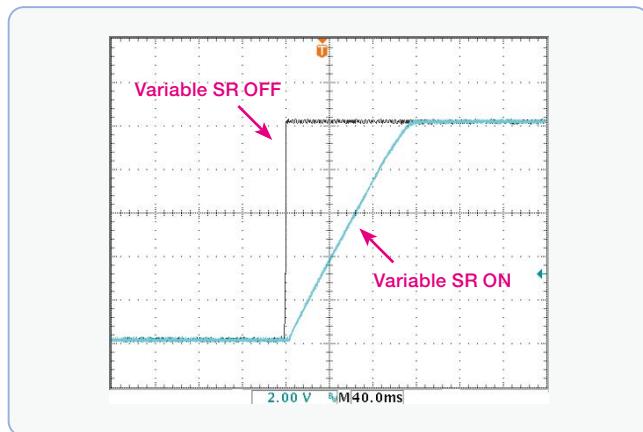

## HI/LO Limit Separate Setting

In voltage or current source, the HI/LO limit settings are very important. The 6253 has a function that can set the HI and LO limits individually. In addition, for the voltage limit, both HI and LO limits can be set homo-polar. This prevents capacitors or batteries from being over-discharged. Also, it is suitable for evaluating devices such as LDs that are used at a constant current and do not tolerate reverse voltage application.

## Suspend Function

The 6253 can select from three output OFF statuses; STBY (output relay OFF), HiZ (output relay ON and high resistance), and LoZ (output relay ON and low resistance). Consequently, unnecessary relay ON/OFF operations can be omitted. Using this function will prevent throughput reduction due to relay operating time, and extend relay lifetime dramatically, increasing product reliability. In addition, the setting of a suspend voltage (voltage in HiZ and LoZ status) can prevent transient current from being generated when connecting voltage sourcing devices such as batteries.

Output OFF status	Output relay	Output status	Current limit setting value
LoZ	ON	Vsus, low resistance	VS: Setting current limit (IL) IS: 3000 digits in the setting current range (10000 digits for the 3 μA range)
HiZ	ON	Vsus, high resistance	100 nA
STBY	OFF	Open	-

## High-Speed Response

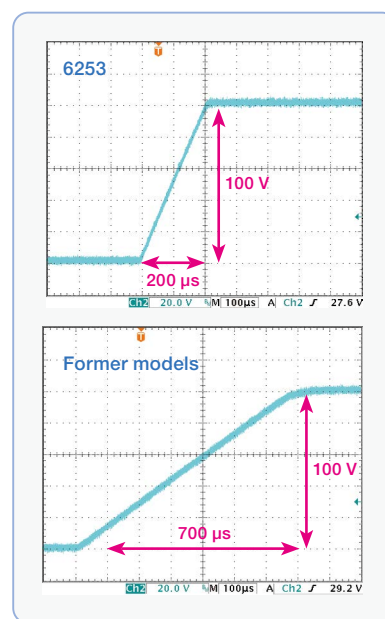

The output response of the 6253 can be switched between Fast and Slow. When the output response is set to Fast, the 6253 starts up faster than the former models.

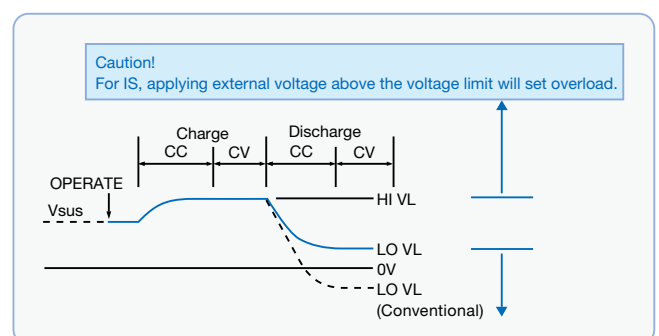



## DC/DC Converter Evaluation

The following functions are effective for DC/DC converter characteristic test.

- The input current and the output voltage or current can be measured simultaneously by synchronizing two units of the 6253.
- $\pm$ Source and  $\pm$ sink by bipolar output

The 6253 allows 0 V sink which is unavailable by normal electronic load.

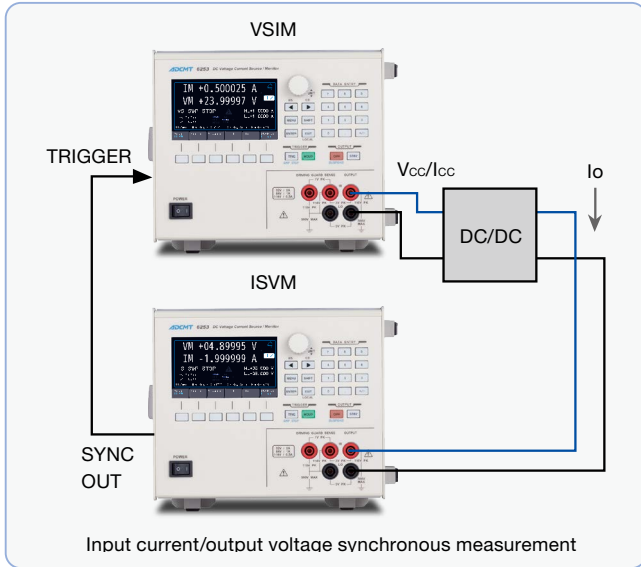

## Diode VF Temperature Dependence Evaluation

Pulse current application is effective for power diode characteristic test to avoid the influence of self-heating.

By using the current pulse sweep function and voltage measurement in synchronization with pulses, precise VF characteristic test is available even with large current.

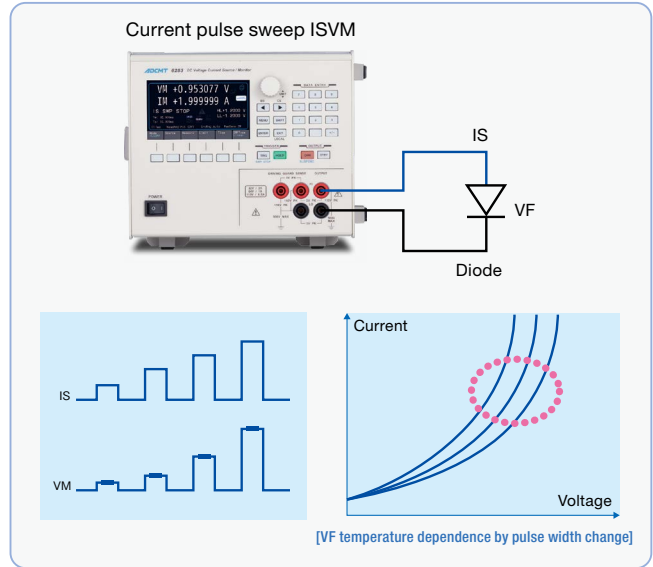

## Protection of Overshoot at Capacitive Load

When a capacitive load is connected, overshoot occurs at the rising or falling edge and the DUT may be damaged or the output becomes unstable.

Using the variable slew rate (SR) function of the 6253 will alleviate voltage waveforms and protect overshoot.

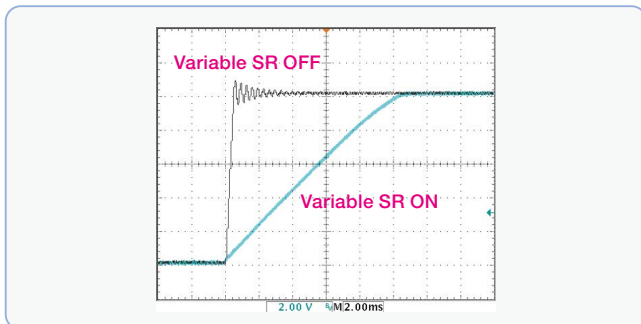

## Average Current Measurement [Variable Integration Function]

The 6253 allows you to set the integration time arbitrarily from 100  $\mu$ s to 1000 ms. This makes it measure easily the average current consumption of mobile phones and LCDs.

As any integration time of the AD converter itself can be set and analog integration is adopted, there are no omissions in waveforms differently from digital integration, resulting in precise average measurement.

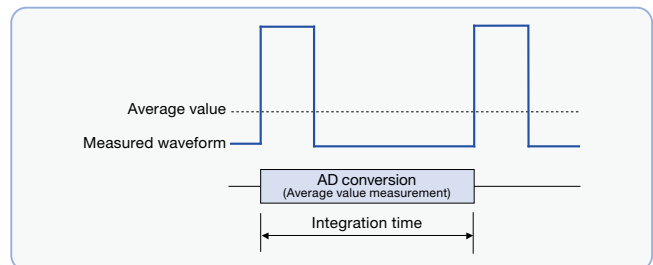

Improved operability with a numeric keypad

Square connector of rear output terminals  
(Connecting plug is supplied)

External control signals (BNC connector)  
For synchronous operation or external device control

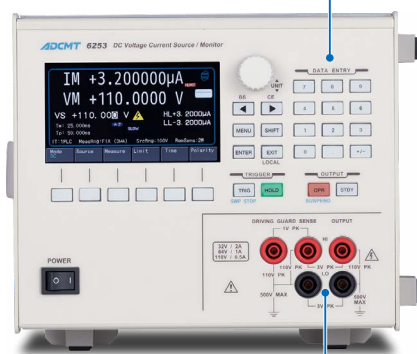

Safety sockets of front output terminals

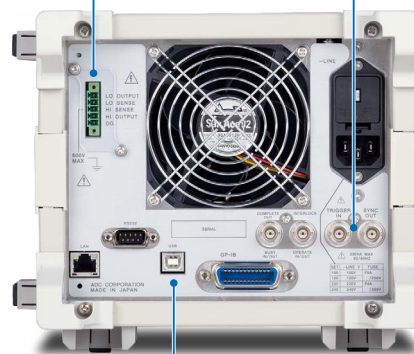

USB and GPIB as standard  
Optional LAN and RS232 (factory option)

## Specifications

All accuracy specifications are guaranteed for one year at a temperature of 23 °C ±5 °C and a relative humidity of 85 % or less.

### Voltage source/measurement range:

Range	Source range	Setting resolution	Measurement range	Measurement resolution <sup>1</sup>
300 mV	0 to ±320.000 mV	5 µV	0 to ±320.9999 mV	100 nV
3 V	0 to ±3.20000 V	50 µV	0 to ±3.209999 V	1 µV
10 V	0 to ±10.0000 V	100 µV	0 to ±10.09999 V	10 µV
30 V	0 to ±32.0000 V	500 µV	0 to ±32.09999 V	10 µV
100 V	0 to ±110.000 V	1 mV	0 to ±110.9999 V	100 µV

### Current source/measurement range:

Range	Source range	Setting resolution	Measurement range	Measurement resolution <sup>1</sup>
3 µA	0 to ±3.20000 µA	50 pA	0 to ±3.209999 µA	1 pA
30 µA	0 to ±32.0000 µA	500 pA	0 to ±32.09999 µA	10 pA
300 µA	0 to ±320.000 µA	5 nA	0 to ±320.9999 µA	100 pA
3 mA	0 to ±3.20000 mA	50 nA	0 to ±3.209999 mA	1 nA
30 mA	0 to ±32.0000 mA	500 nA	0 to ±32.09999 mA	10 nA
300 mA	0 to ±320.000 mA	5 µA	0 to ±320.9999 mA	100 nA
2 A	0 to ±2.00000 A	50 µA	0 to ±2.009999 A	1 µA

<sup>1</sup>The measurement resolution with integration time of 5 µs, 10 µs, 100µs and 500µs will be as follows:

Integration time	5 µs	10 µs	100 µs	500 µs
Measurement resolution (digits)	20	10	4	2

### Resistance measurement range:

Range	Measurement range	Measurement resolution
Determined by voltage range/ current range calculations	0 Ω to 550 GΩ	Minimum 0.05 µΩ

### Voltage limit (compliance) range:

Setting range	Setting resolution <sup>2</sup>
0 V to 320.00 mV	10 µV
320.01 mV to 3.2000 V	100 µV
3.2001 V to 10.000 V	1 mV
10.001 V to 32.000 V	1 mV
32.001 V to 110.00 V	10 mV

### Current limit (compliance) range:

Setting range	Setting resolution <sup>2</sup>
0.0010 µA to 3.2000 µA	100 pA
3.2001 µA to 32.000 µA	1 nA
32.001 µA to 320.00 µA	10 nA
320.01 µA to 3.2000 mA	100 nA
3.2001 mA to 32.000 mA	1 µA
32.001 mA to 320.00 mA	10 µA
320.01 mA to 2.0000 A	100 µA

<sup>2</sup>: Where, (Hi limit value – Lo limit value) ≥ 600 digits (2000 digits for 3 µA range)

Accuracy: Includes calibration accuracy, 1-day stability, temperature coefficient, and linearity.

### Voltage source:

Range	Accuracy	1-day stability	Temperature coefficient
	±(% of setting + V)		±(ppm of setting + V)/°C
300 mV	0.02 + 150 µV	0.008 + 80 µV	15 + 15 µV
3 V	0.02 + 200 µV	0.008 + 100 µV	15 + 30 µV
10 V	0.02 + 600 µV	0.008 + 500 µV	15 + 100 µV
30 V	0.02 + 2 mV	0.008 + 1 mV	15 + 300 µV
100 V	0.02 + 6 mV	0.008 + 5 mV	15 + 1 mV

### Voltage limit:

Range	Accuracy	1-day stability	Temperature coefficient
	±(% of setting + V)		±(ppm of setting + V)/°C
300 mV	0.025 + 250 µV	0.01 + 100 µV	15 + 30 µV
3 V	0.025 + 500 µV	0.01 + 300 µV	15 + 50 µV
10 V	0.025 + 5 mV	0.01 + 3 mV	15 + 500 µV
30 V	0.025 + 5 mV	0.01 + 3 mV	15 + 500 µV
100 V	0.025 + 50 mV	0.01 + 20 mV	15 + 2 mV

Voltage limit additional error: When Hi limit is set negative and Lo limit is set positive, an error of ±0.1% of setting is added.

### Current source:

Range	Accuracy	1-day stability	Temperature coefficient
	±(% of setting + A + A × Vo/1 V)		±(ppm of setting + A + A × Vo/1 V)/°C
3 µA	0.03 + 500 pA + 30 pA	0.01 + 300 pA + 20 pA	20 + 150 pA + 1 pA
30 µA	0.03 + 4 nA + 300 pA	0.01 + 2.5 nA + 200 pA	20 + 1 nA + 10 pA
300 µA	0.025 + 40 nA + 3 nA	0.01 + 25 nA + 2 nA	20 + 10 nA + 100 pA
3 mA	0.025 + 350 nA + 30 nA	0.008 + 200 nA + 20 nA	20 + 100 nA + 1 nA
30 mA	0.025 + 3.5 µA + 300 nA	0.008 + 2 µA + 200 nA	20 + 1 µA + 10 nA
300 mA	0.03 + 35 µA + 3 µA	0.01 + 20 µA + 2 µA	20 + 10 µA + 100 nA
2 A	0.04 + 350 µA + 30 µA	0.015 + 250 µA + 20 µA	20 + 100 µA + 1 mA

### Current limit:

Range	Accuracy	1-day stability	Temperature coefficient
	±(% of setting + A + A × Vo/1 V)		±(ppm of setting + A + A × Vo/1 V)/°C
3 µA	0.03 + 1.5 nA + 30 pA	0.01 + 500 pA + 20 pA	20 + 200 pA + 1 pA
30 µA	0.03 + 10 nA + 300 pA	0.01 + 3 nA + 200 pA	20 + 1 nA + 10 pA
300 µA	0.03 + 100 nA + 3 nA	0.01 + 30 nA + 2 nA	20 + 10 nA + 100 pA
3 mA	0.03 + 1 µA + 30 nA	0.01 + 300 nA + 20 nA	20 + 100 nA + 1 nA
30 mA	0.03 + 10 µA + 300 nA	0.01 + 3 µA + 200 nA	20 + 1 µA + 10 nA
300 mA	0.05 + 100 µA + 3 µA	0.015 + 30 µA + 2 µA	20 + 10 µA + 100 nA
2 A	0.06 + 1 mA + 30 µA	0.03 + 300 µA + 20 µA	20 + 100 µA + 1 mA

### Vo: Compliance voltage

#### Voltage measurement: (Auto zero: ON, integration time: 1PLC to 200ms)

Range	Accuracy	1-day stability	Temperature coefficient
	±(% of reading + V)		±(ppm of reading + V)/°C
300 mV	0.02 + 120 µV	0.006 + 60 µV	15 + 12 µV
3 V	0.02 + 120 µV	0.006 + 80 µV	15 + 15 µV
10 V	0.02 + 500 µV	0.006 + 200 µV	15 + 50 µV
30 V	0.02 + 1.2 mV	0.006 + 800 µV	15 + 150 µV
100 V	0.02 + 5 mV	0.006 + 2 mV	15 + 500 µV

#### Current measurement: (Auto zero: ON, integration time: 1PLC to 200ms)

Range	Accuracy	1-day stability	Temperature coefficient
	±(% of reading + A + A × Vo/1 V)		±(ppm of reading + A + A × Vo/1 V)/°C
3 µA	0.025 + 500 pA + 30 pA	0.01 + 300 pA + 20 pA	20 + 100 pA + 1 pA
30 µA	0.025 + 4 nA + 300 pA	0.01 + 2.5 nA + 200 pA	20 + 500 pA + 10 pA
300 µA	0.025 + 35 nA + 3 nA	0.01 + 25 nA + 2 nA	20 + 5 nA + 100 pA
3 mA	0.025 + 300 nA + 30 nA	0.01 + 200 nA + 20 nA	20 + 40 nA + 1 nA
30 mA	0.025 + 3 µA + 300 nA	0.01 + 2 µA + 200 nA	20 + 400 nA + 10 nA
300 mA	0.03 + 30 µA + 3 µA	0.01 + 20 µA + 2 µA	20 + 4 µA + 100 nA
2 A	0.04 + 300 µA + 30 µA	0.015 + 250 µA + 20 µA	20 + 40 µA + 1 mA

#### Resistance measurement: (Auto zero: ON, integration time: 1PLC to 200ms)

Condition	Accuracy
	±(% of reading) ±(digits + digits + digits)
Voltage source	Reading error: (Voltage source setting error + Current measurement reading error) Full-scale error: (Voltage source full-scale error digit value + current measurement full-scale error digit value + CMV error digit value) <sup>3</sup>
Current source	Reading error: (Current source setting error + Voltage measurement reading error) Full-scale error: (Current source full-scale error digit value + Voltage measurement full-scale error digit value + CMV error digit value) <sup>3</sup>

### Vo: Compliance voltage

<sup>3</sup>: CMV error = (A × Vo/1 V); "source or measurement current" × "source or measurement voltage"/1 V digit value

The full-scale error tolerances listed below are added to the integration time 10 ms to 5  $\mu$ s and 1-day stability.

	Measurement range	Integration time Unit: digits (at 6 1/2 digit display)					
		10 ms	1 ms	500 $\mu$ s	100 $\mu$ s	10 $\mu$ s	5 $\mu$ s
Voltage measurement	300 mV	150	200	400	600	8000	10000
	3 V	50	100	200	300	5000	8000
	10 V	50	100	200	300	5000	8000
	30 V	50	100	200	300	5000	8000
	100 V	50	100	200	300	5000	8000
Current measurement	3 $\mu$ A	600	1000	1500	2000	5000	10000
	30 $\mu$ A	200	300	300	300	5000	10000
	300 $\mu$ A	100	100	200	300	5000	8000
	3 mA	100	100	200	300	5000	8000
	30 mA	100	100	200	300	5000	8000
	300 mA	100	100	200	300	5000	8000
	2 A	100	100	200	300	5000	8000

Source linearity:  $\pm 10$  digits or less

Maximum output current:  $\pm 2$  A at  $\pm 32$  V  
 $\pm 1$  A at  $\pm 64$  V  
 $\pm 0.5$  A at  $\pm 110$  V

Maximum compliance voltage:  $\pm 110$  V at  $\pm 0.5$  A  
 $\pm 64$  V at  $\pm 1$  A  
 $\pm 32$  V at  $\pm 2$  A

Output noise: For voltage source, within the range from no load to the maximum load [Vp-p]  
For current source, at the following load [Ap-p]

Voltage source:

Range	Load resistance	Low frequency noise		High frequency noise
		DC to 100 Hz	DC to 10 kHz	DC to 20 MHz
300 mV	-	60 $\mu$ V	300 $\mu$ V	5 mV
3 V	-	100 $\mu$ V	400 $\mu$ V	5 mV
10 V	-	1 mV	3 mV	6 mV
30 V	-	1 mV	3 mV	6 mV
100 V	-	3 mV	5 mV	10 mV

Current source:

Range	Load resistance	Low frequency noise		High frequency noise
		DC to 100 Hz	DC to 10 kHz	DC to 20 MHz
3 $\mu$ A	10 k $\Omega$	10 nA	60 nA	500 nA
30 $\mu$ A	10 k $\Omega$	10 nA	60 nA	500 nA
300 $\mu$ A	10 k $\Omega$	30 nA	150 nA	600 nA
3 mA	1 k $\Omega$	200 nA	2 $\mu$ A	6 $\mu$ A
30 mA	1 k $\Omega$	2 $\mu$ A	15 $\mu$ A	20 $\mu$ A
300 mA	1 k $\Omega$	20 $\mu$ A	100 $\mu$ A	150 $\mu$ A
2 A	100 $\Omega$	200 $\mu$ A	1 mA	1.5 mA

Switching noise:

		Typical value [p-p]	Load resistance
Output ON/OFF noise	Voltage source	600 mV	At 100 k $\Omega$
	Current source	600 mV	
Range switching noise	Voltage source	50 mV	-
	Voltage limit	50 mV <sup>4</sup>	
	Voltage measurement	50 mV <sup>4</sup>	
	Current source	700 digits + 50 mV <sup>5</sup>	
	Current measurement		
Current limit			
Power OFF noise		600 mV	At 100 k $\Omega$

\*4: The limit operation is inactive. While the limit operation is active, it is the same as the current source range switching noise.

\*5: "digits" indicates current source values at 5 1/2 digits.

Settling time: Time to reach the final value  $\pm 0.1\%$

Under the conditions of pure resistance load, load capacitance of 2.5 pF or less, full-scale compliance settings. For voltage source in the 100 V range, the output current should be less than 20 % or less of the limit setting values.

(Typical value)	Source range	Limit range	Output response	
			FAST	SLOW
Voltage source	300 mV	2 A	100 $\mu$ s	1 ms
	3 V			
	10 V			
	30 V			
	100 V			
Current source	3 $\mu$ A	100 V	300 $\mu$ s	3 ms
	30 $\mu$ A			
	300 $\mu$ A			
	3 mA			
	30 mA			
	300 mA			
	2 A			
	30 V			
	300 mA			
	2 A			

Overshoot:  $\pm 5$  % or less under pure resistance load and at the standard cable end  
(3  $\mu$ A, 30  $\mu$ A and 300  $\mu$ A ranges excluded)

Line regulation:  $\pm 0.003\%$  of range or less

Load regulation: Voltage source:  $\pm 0.003\%$  of range or less  
(At 4-wire connection under the maximum load)  
Current source: Depending on the accuracy CMV (A  $\times$  V<sub>o</sub>/1V)

Output resistance: At 4-wire connection, not including the output cable

Maximum load capacitance: Maximum load capacitance that does not generate oscillation in voltage source or voltage limit status

Output resistance ( $\Omega$ )			Maximum load capacitance
Current range	Voltage source	Current source	
3 $\mu$ A	3 $\Omega$ or less	10 G $\Omega$ or higher	1 $\mu$ F
30 $\mu$ A	500 m $\Omega$ or less	1000 M $\Omega$ or higher	1 $\mu$ F
300 $\mu$ A	100 m $\Omega$ or less	1000 M $\Omega$ or higher	1 $\mu$ F
3 mA	10 m $\Omega$ or less	100 M $\Omega$ or higher	100 $\mu$ F
30 mA	10 m $\Omega$ or less	10 M $\Omega$ or higher	100 $\mu$ F
300 mA	10 m $\Omega$ or less	1 M $\Omega$ or higher	2000 $\mu$ F
2 A	10 m $\Omega$ or less	100 k $\Omega$ or higher	2000 $\mu$ F

Supplied cable resistance: 100 m $\Omega$  or less

Maximum inductive load: Maximum inductive load that does not generate oscillation in current source or current limit status

Current source range/ current limit range	Response	3 $\mu$ A, 30 $\mu$ A	300 $\mu$ A	3 mA to 2 A
	Maximum inductive load	FAST	100 $\mu$ H	200 $\mu$ H
SLOW		100 $\mu$ H	500 $\mu$ H	1 mH

Effective CMRR: At unbalanced impedance 1k $\Omega$   
In DC and at AC 50/60 Hz  $\pm 0.08\%$

	Integration time	
	5 $\mu$ s to 10 ms	1 PLC to 200 ms
Current measurement/ voltage measurement	60 dB	120 dB

NMRR: At AC 50/60 Hz  $\pm 0.08\%$

	Integration time	
	5 $\mu$ s to 10 ms	1 PLC to 200 ms
Voltage measurement/ current measurement	0 dB	60 dB

## Source and Measurement Function

DC source and measurement: DC voltage and current source and measurement

Pulse source and measurement: Source and measurement of pulse voltage and current  
(However, measurement auto range in pulse source is impossible.)

DC sweep source and measurement: Source and measurement by Linear, Multi-slope linear, Log, Random and Fixed level

Pulse sweep source and measurement: Source and measurement by Linear, Multi-slope linear, Log, Random and Fixed level  
(However, measurement auto range in pulse source is impossible.)

Source value monitor: Monitoring source values of DC voltage and current (Measured separately from the measurement function)

Integration time: 10 types available: 5  $\mu$ s, 10  $\mu$ s, 100 $\mu$ s, 500 $\mu$ s, 1ms, 10ms, 1PLC, 2 PLC, 200 ms and arbitrary value (variable integration)  
(PLC: Power Line Cycle, 50 Hz: 20 ms, 60 Hz: 16.66 ms)

Variable integration setting range: 100  $\mu$ s to 1000 ms (setting resolution: 100  $\mu$ s)

Sweep mode: Reverse ON (round) / OFF (one way)

Sweep repeat count: 1 to 1,000 times or infinite

Maximum number of sweep steps: 20,000 steps

Maximum random sweep memory: 20,000 data

Sampling count: 1 to 20,000 times  
(Plural samplings done by single trigger)  
(Valid only in the HOLD status of the DC or pulse mode)

Measurement data memory: 20,000 data

Measurement auto range: Available only in VSIM or ISVM

Measurement function link mode: Links the measurement function to the source function.  
VSIM or ISVM, ON/OFF available

Limit: The HI and LO limits can be set individually.  
(However, current limits of the same polarity are not allowed.)

Calculation function: NULL calculation  
Comparator calculation (HI, GO, or LO)  
Scaling calculation  
MAX, MIN, AVE, TOTAL calculations

Trigger style: Auto trigger, External trigger

Output terminal: Front safety socket  
Rear HI OUTPUT, HI SENSE, LO OUTPUT, LO SENSE, DRIVING GUARD

Maximum input voltage: 110 V peak (between HI-LO, DG-LO)  
3 V peak (between OUTPUT and SENSE)  
1 V peak (between HI and DG)  
500 V max (between LO and chassis)

Maximum remote sensing voltage:  $\pm 3$  V max  
HI OUTPUT - HI SENSE,  
LO OUTPUT - LO SENSE  
(The voltage between HI SENSE and LO SENSE must be within the maximum output voltage range.)

Voltage measurement input resistance: 10 G $\Omega$  or higher

Voltage measurement input leak current:  $\pm 100$  pA or lower

## Interface Function

USB interface: USB 2.0 Full-speed, Type B connector

GPIB interface: Compliant with IEEE-488.2  
Amphenol 24 pin connector  
Interface function SH1, AH1, T6, L4, SR1, RL1, PP0, DC1, DT1, C0, E2

RS232 interface (factory option): Compliant with EIA232C (RS-232)  
Baud rate 19200, 9600, 4800, 2400, 1200, 600, 300  
Parity EVEN, ODD, NONE  
Number of data bits 7 bits, 8 bits  
Number of stop bits 1 bit, 2 bits  
Dsub 9 pin connector

LAN interface (factory option): Compliant with IEEE802.3  
10BASE-T, 100BASE-TX  
RJ-45 connector

External control signal: TRIGGER IN  
SYNC OUT  
COMPLETE OUT/BUSY IN/BUSY OUT  
INTERLOCK/OPERATE IN/OPERATE OUT  
BNC connector

## Setting Time

Minimum pulse width: 25  $\mu$ s

Minimum step (repeat) time:  
Under fixed source/measurement range, integration time of 5  $\mu$ s, the minimum measurement or source delay time, calculation function OFF, auto zero OFF, and voltage/current measurement

Measurement	Source mode	Memory mode	Minimum step time
OFF	DC, DC sweep	OFF, Normal	100 $\mu$ s
	Pulse, pulse sweep		125 $\mu$ s
	Common mode	Burst	50 $\mu$ s
ON	DC, pulse	Normal	250 $\mu$ s <sup>*6</sup>
		OFF	
	Sweep	Burst	50 $\mu$ s
		Normal	250 $\mu$ s <sup>*6</sup>
	OFF		

\*6: 500  $\mu$ s when the calculation function is OFF

### Source delay time:

Setting range	Resolution <sup>*7</sup>	Setting accuracy
0.005 ms to 60.000 ms	1 $\mu$ s	$\pm(0.1 \% + 10 \mu\text{s})$
60.01 ms to 600.00 ms	10 $\mu$ s	
600.1 ms to 6000.0 ms	100 $\mu$ s	
6001 ms to 59997 ms	1 ms	

### Period (pulse cycle):

Setting range	Resolution <sup>*7</sup>	Setting accuracy
0.050 ms to 60.000 ms	1 $\mu$ s	$\pm(0.1 \% + 10 \mu\text{s})$
60.01 ms to 600.00 ms	10 $\mu$ s	
600.1 ms to 6000.0 ms	100 $\mu$ s	
6001 ms to 60000 ms	1 ms	

### Pulse width:

Setting range	Resolution <sup>*7</sup>	Setting accuracy
0.025 ms to 60.000 ms	1 $\mu$ s	$\pm(0.1 \% + 10 \mu\text{s})$
60.01 ms to 600.00 ms	10 $\mu$ s	
600.1 ms to 6000.0 ms	100 $\mu$ s	
6001 ms to 59997 ms	1 ms	

### Measurement delay time:

Setting range	Resolution <sup>*7</sup>	Setting accuracy
0.020 ms to 60.000 ms	1 $\mu$ s	$\pm(0.1 \% + 10 \mu\text{s})$
60.01 ms to 600.00 ms	10 $\mu$ s	
600.1 ms to 6000.0 ms	100 $\mu$ s	
6001 ms to 59997 ms	1 ms	

\*7: The setting resolution is determined by the period time resolution.

Hold time:		
Setting range	Resolution	Setting accuracy
0 ms to 6000.0 ms	100 $\mu$ s	$\pm$ (2 % + 2 ms)

Auto range delay time:

Setting range	Resolution	Setting accuracy
0 ms to 5000.0 ms	100 $\mu$ s	$\pm$ (2 % + 2 ms)

## General Specifications

Operating environment: Temperature: 0°C to +50°C  
 Relative humidity: 85% or less, no condensation  
 The operating temperature environment is limited at sink.

Storage environment: Temperature: -25°C to +70°C  
 Relative humidity: 85% or less, no condensation

Warm-up time: 60 minutes or more

Display: 4.3-inch color LCD display

Power supply: AC power supply 100V/120V/220V/240V (User selectable)

Option number	Standard	OPT. 32	OPT. 42	OPT. 44
Power voltage	100 V	120 V	220 V	240 V

Use a power cable and a fuse that are compliant with the safety standard when changing the power supply voltage.

Line frequency: 50Hz/60Hz

Power consumption: 330 VA or less

Dimensions: Approx. 212 (W) x 177 (H) x 450 (D) mm

Mass: 15 kg or less

Safety: Compliant with IEC61010-1 Ed.3

EMI: EN61326-1 class A

Vibration proof: Compliant with IEC60068-2-6 2G

### Supplied accessories

Name	Model	Quantity
Power cable	A01402	1
Input/output cable (red and black safety cable 1m)	A01044	1
Banana tip adapter (red and black)	A08531	1
Alligator clip adapter (red and black)	A08532	1
Output connector (plug)	JCS-RB0005JX04	1
Output connector (plug) cover	YEE-1000734	1
Cable tie	ESM-000257	1

### Optional accessories

Name	Model
Test fixture	12701A
Input cable (1 m)	A01041
Input/output cable (red and black safety cable 1m)	A01044
Banana tip adapter (red and black)	A08531
Alligator clip adapter (red and black)	A08532
Input and output cable (banana-banana, 4-wire shielded, 0.5 m)	A01047-01
Input and output cable (banana-banana, 4-wire shielded, 1 m)	A01047-02
Input and output cable (banana-banana, 4-wire shielded, 1.5 m)	A01047-03
Input and output cable (banana-banana, 4-wire shielded, 2 m)	A01047-04
Input and output cable (banana-banana, 4-wire shielded with guard, 1 m)	A01038-100
Input and output cable (5-pin plug - alligator, 1 m)	CC060001-100
Input and output cable (5-pin plug, 2 m)	CC060002-200
Input cable (BNC-BNC, 1.5 m)	A01036-1500
Rack mount set (JIS 4U single)	A02269
Rack mount set (JIS 4U twin) <sup>*8</sup>	CC022004
Rack mount set (EIA 4U single)	A02469
Rack mount set (EIA 4U twin) <sup>*8</sup>	CC024004
Side joint set (4U)	A02641
Slide rail set	A02615
Front handle set (4U)	CC028004

\*8: Installing a rack or the slide rail set (A02165) is required.  
 The side joint set (A02641) is required.

### Options

Name	Model
RS232 interface (factory option)	OPT6253+03
LAN interface (factory option)	OPT6253+06

- Please read through the operation manual carefully before using the product.
- All specifications are subject to change without notice.



**ADC CORPORATION**

**E-mail : kcc@adcmt.com URL : https://www.adcmt.com**

#### Head Office (R&D Center)

77-1, Miyako Namegawa-machi, Hiki-gun,  
 Saitama 355-0812, Japan  
 Phone: +81-493-56-4433 Fax: +81-493-57-1092

#### East Branch (Sales Dept.)

Okabe-building, 3-515, Onari-cho, Omiya-ku, Saitama-shi,  
 Saitama 330-0852, Japan  
 Phone: +81-48-651-4433 Fax: +81-48-651-4432