



# Simple! Secure! Safety!



Short-circuit current: **200 mA** or more!<sup>\*</sup>  
Max rated output: **500 VA**

<sup>\*</sup> When the output voltage is 1.0 kV or greater

## Hipot (Withstanding Voltage) & Insulation Resistance Tester **TOS5300 Series**

- The PWM amp system provides highly-stable output
- 5 kV/100 mA (500 VA) AC Hipot (withstanding voltage) test
- 6 kV/maximum output 50 W DC Hipot (withstanding voltage) tester (TOS5301)
- 25 V-1000 V (7 steps), 500 V or greater, up to 5.00 GΩ Insulation Resistance test
- High-precision measurement ±1.5 % of reading (with voltmeter 500 V or higher, Ammeter 1 mA or higher)
- Rise time/Fall time control
- Key lock function and Protection cover for key operation
- Equipped with USB interface



# Highly stable

Newly developed, high-efficiency  
PWM switching amplifier!

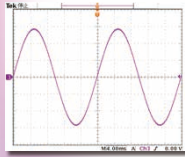

▲Output voltage wave form

Providing a stable output of high voltage without being affected by AC line variation. Ensure the user to perform highly reliable testing with confidence, even in regions with large voltage variations. (Input voltage fluctuation rate:  $\pm 0.3\%$ )

# Rise/Fall Time control function of the applied voltage

Equipped with a Rise time/  
Fall time control function

Prevents from an excessive stress applied to the EUT or for standard tests.

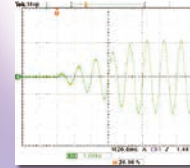

▲Rise time control waveform (example)

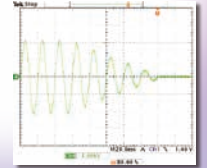

▲Fall time control waveform (example)

# Reducing the tact time

Increasing the productivity!

Capable of setting the test time from 0.1s

# Simple! Secure! Safety!

# Supporting the World-wide input voltage

Usable globally!

Usable in any country without changing the input power supply.

Selectable output frequency!

The instrument not rely on the input power environment. Supplying the stable test voltage with 50/60 Hz frequencies.

# A new standard for Hipot (Withstanding voltage) & Insulation resistance testing Applied to World-Wide input voltage

# Lightweight & Compact design

Increasing your work efficiency!

Weights Approx. 15 kg  
40% lighter than conventional models  
\*Compared to TOS5300 and TOS8870A

# Pursuing usability and safety

All new design of the control panel and output terminals!

Eliminates the projected components of output terminals, and equips with a new type of the LOW terminal. Pursuing the improvement of safety and a convenience in production line, such as providing the protection cover for the front panel.



▲Output terminal  
Left : HIGH (red)  
Right : LOW (black, with lock function)



▲View with the protection cover removed from front panel

Short-circuit current: **200 mA** or more!  
Max rated output: **500 VA**



\* When the output voltage is 1.0 kV or greater

Hipot (Withstand-Voltage) & Insulation Resistance Tester

# TOS5300 Series

3 model

The "TOS5300 Series" is a series of test instruments used in Hipot (withstanding voltage) tests and insulation resistance tests, two of the four tests regarded as necessary for ensuring the safety of electrical products. With an output of 5 kV/100 mA (AC) and 6 kV/10 mA (DC), the series can be used in Hipot (withstanding voltage) & insulation resistance testing of electronic equipment and electronic parts, based on the requirements of IEC, EN, UL, VDE, JIS, and other international safety standards and the Electrical Appliance and Material Safety Law. Also, the test voltage stability is improved with the adoption of a newly developed switching amplifier. Since the output voltage can be kept constant even when the AC line voltage or frequency changes, consistent testing can be performed, even when the power supply environment is in an unstable region. The TOS5300 is also equipped with a number of features that are capable of meeting a variety of test needs. It is a new low-cost standard model that provides thorough operability, reliability and safety.

Applied test / Model	TOS5300	TOS5301	TOS5302
AC Hipot (Withstanding voltage) test (ACW)	✓	✓	✓
DC Hipot (Withstanding voltage) test (DCW)		✓	
Insulation Resistance test (IR)			✓

## Features and Functions

- ACW: 5 kV/100 mA; DCW: 6 kV/50 W ●IR: 25-1000 V (7 steps)/500 V or greater, up to 5.00 GΩ ●High-precision measurement  $\pm 1.5\%$  of reading (Voltage: 500 V or greater ; Current: 1 mA or more) ●Rise time / Fall time control function ●Discharge function ●World-wide input voltage ●AUTO function ●USB interface ●Panel memory function (3 sets) ●Key lock and Protection cover for panel operation

## The achievement of AC Hipot (Withstanding voltage) testing with a constant stable output!

[ Input voltage variation :  $\pm 0.3\%$  ]

The output waveform is essential factor in Hipot (Withstanding voltage) testing!

A conventional Hipot (Withstanding voltage) tester boosts and outputs the AC line's input voltage through the use of a slide transformer. With this slide transformer system, input voltage fluctuations will affect the output, preventing tests from being performed properly. At times, the application of distortion voltage applied to the EUT may cause a failure of new product (accelerating a deterioration of components). Since the TOS5300 Series equips with a high-efficient PWM amplifier that can output a stable high-voltage without being affected by the variation of AC power line, users can perform "safe", "stable", and highly "reliable" tests with confidence, even in regions with large voltage variations.

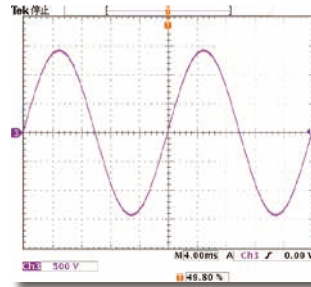
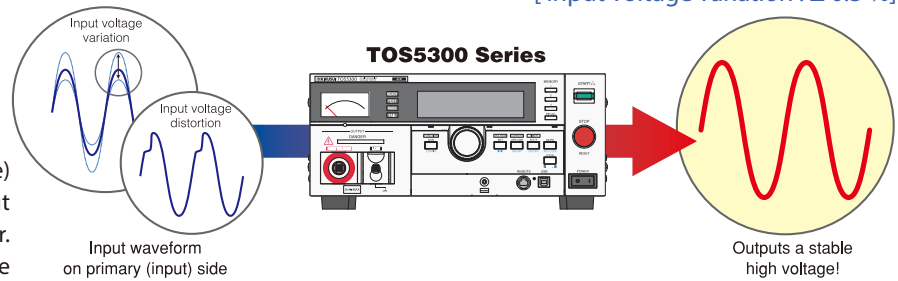

▲ AC output waveform of the TOS5300 Series

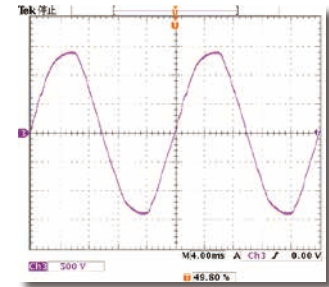

▲ AC output waveform of the slide transformer system

## Realizing high-precision measurement with high-resolution and high-speed judgement

Equipped with a high-accuracy, high-resolution of True RMS measurement circuit, including a Voltmeter with  $\pm 1.5\%$  of reading (500 V or greater) / minimum resolution of 1V, and an Ammeter with  $\pm 1.5\%$  of reading (1 mA or more) / minimum resolution of 1  $\mu$ A. In addition, it is also equipped with an Auto range function. The Lower limit judgment accuracy achieves a level of performance equivalent to the Upper limit judgment accuracy that enables to detect for such a poor contact or disconnections of test leads. Moreover, it realizes the fast judgment by the test time of 0.1 second, while reliable testing can be performed, thanks to high-precision, high-resolution, high-speed measurement and the judgment functions.

**This is different, too!**

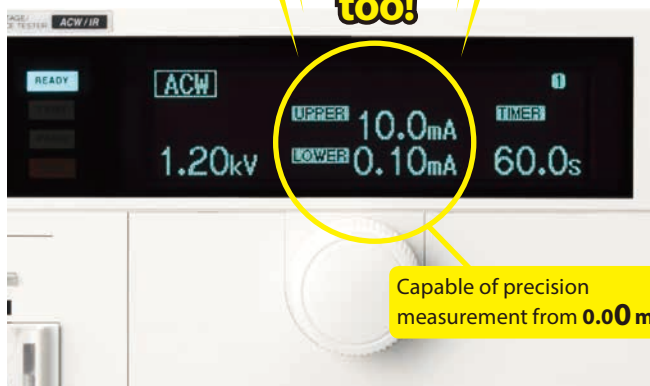

Capable of precision measurement from **0.00 mA**

▲ AC Hipot (Withstanding voltage) test settings display (example)

## Supporting the World-wide input voltage

Usable globally !

Usable in any country, without changing the input power supply.

Selectable output frequency !

The instrument not rely on the input power environment.

Supplying the stable test voltage with 50/60 Hz frequencies.



## Reducing the tact time

Reduction of the tact time leads to improve the productivity. However, it has been an issue that reducing the tact time may cause to worsen the measurement accuracy when the test time is faster than the measuring response speed. The TOS5300 series has been achieved to set the test time from 0.1 s.

(Model TOS5301)

## 6 kV/50 WDC Hipot (Withstanding voltage) test

Capable to perform DC Hipot (Withstanding voltage) test up to 6 kV. (Model TOS5301) Equipped with a stable DC/DC converter with a low-ripple and the load variation of 3 % or less.

## Insulation resistance test for 25 V to 1000 V\*

The TOS5302 is equipped with an insulation resistance tester. The test voltages can be set from 25 V, 50 V, 100 V, 125 V, 250 V, 500 V and 1000 V. And for setting at 500 V and above, it can perform the insulation resistance test up to 5.00 G $\Omega$ .

\*At 500 V and above, measurements up to 5.00 G $\Omega$  are possible.

## Protection cover prevents physical operation error in the production site

Prevents a physical operation error by installing the protection cover on the control keys.



In many cases, workers on electronic equipment production lines and inspection lines are not technical experts. Therefore, it is possible that the operators may change setting conditions and make operation errors. In order to prevent from such cases, the TOS5302 is equipped with a key lock function and a protection cover to disable a physical key operation from the front panel.



▲View with the protection cover removed

Storing the protection cover for the key operation to the base of unit. ▶ During the periods of operation with the protection cover removed, such as when the test conditions are frequently changed and tests are performed repeatedly, the protection cover can be stored at the base.

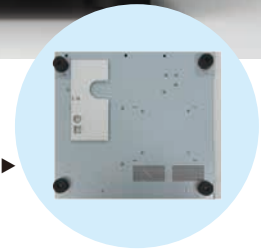

## New design of output terminal improves safety and functionality

Eliminates the projected components from the front panel. The new design of LOW terminal.

In consideration of safety for the operator and the environment, the output terminal of HIGH-side has been placed in the most distant location from the control area. The free rotation mechanism protects from twisting (or breaking) of the cable. Also, with having the lock function for the LOW terminal on the main unit, the metal plate is no longer attached to the test lead of LOW-side, and it makes to resist damage to the test lead. Because of elimination of these projected components, the TOS5302 can avoid from unexpected accidents such as when the unit travels to other location. And also when the test lead is snagged on something, or unexpected stress is applied on the test lead, the High (High-voltage) test lead is designed to disconnect easily, but the Low (ground) test lead is designed to resist disconnection.

In order to prevent the insertion error, the color coding of the cable are classified to HIGH (red) and LOW (black), and the plug shape of terminal are also different design.

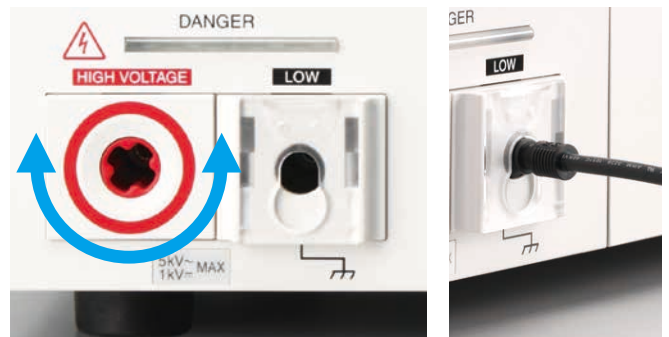

▲Flat surface design of the HIGH terminal with free rotation mechanism, and the LOW terminal with lock function

### POINT

It could be a cause of defect if the cable are incorrectly wired for the HIGH (High-voltage) side and LOW (Low-voltage) side. In order to prevent the insertion error, the protection plate is attached to the Low-voltage (Black) test lead.

## Monitoring the output voltage and protection when applying an overvoltage by the operation error

### LIMIT VOLTAGE function

Prevents the user from setting a test voltage that exceeds the preset voltage.

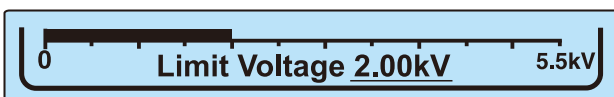

▲LIMIT VOLTAGE setting (example)

### Monitoring output voltage function

If the output voltage exceeds the setting voltage of ( $\pm 350$  V), it turns off the output and the system switches to PROTECTION mode. In order to handle kilo's of high voltage when the Hipot (Withstand voltage) and insulation tests are conducted, there are number of safety measures are required to take place. Having with these functions improve, the operational safety and the protection for the EUT.

## Rise time / Fall time control function

### Rise time control function

The Rise time control function enables you to increase the test voltage gradually to reach the setting voltage while the AC Hipot (Withstanding voltage) test is conducted. The voltage rise time can be set from 0.1 s to 10.0 s at a resolution of 0.1 s.

### Fall time control function

The Fall time control function enables you to decrease the test voltage gradually when the PASS judgment is made at the AC Hipot (Withstanding voltage) test. The voltage fall time is fixed at 0.1 s. (OFF is also selectable).

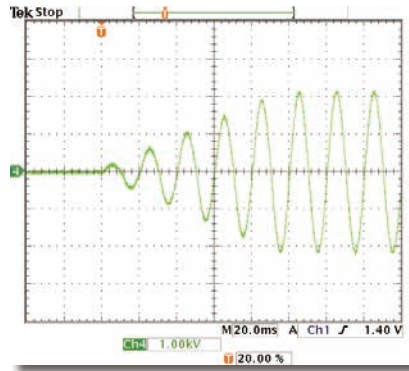

▲ Rise time control waveform (example)

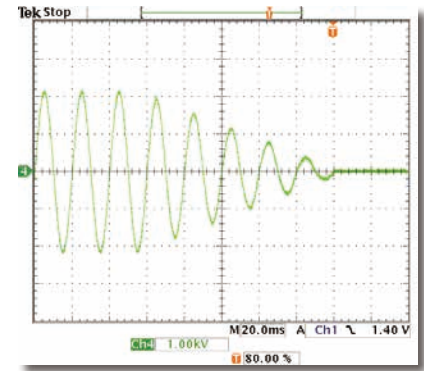

▲ Fall time control waveform (example)

## POINT

The rise time control function is to prevent the EUT (test object) from being exposed to stress that exceeds the required amount. The Hipot (Withstanding voltage) test is conducted to verify the safety performance of the EUT and which test voltage for Hipot (Withstanding voltage) test is applied approximately five to ten times greater than the voltage that handles by the EUT. If a high voltage is applied rapidly with no rise time, the transitional large voltage (current) will be occurred, and it may cause a damage to the EUT. If, as a result of the test, the EUT is suffered of the insulation (dielectric) breakdown, the failure of defect can easily be identified without any problem. However, when breakage is occurred partially, it becomes hard to identify the problem. In other words there are cases in which "at a glance, a Hipot (Withstanding voltage) test appears to have been successfully passed, however, the fact is found that the insulation performance has degraded." In such cases there is a potential risk of danger that the insulation failure will occur after the EUT has been released into the market as a commercial product. The result of testing performed to confirm safety may cause the loss of product's safety. For this reason, safety standards stipulate the procedure of Hipot (Withstanding voltage) test, and the test voltage must be gradually increased to the specified voltage when the test is performed. The rise time control function adopted in the in the TOS5300 Series can set the voltage rise time from 0.1 s to 10.0 s (at a resolution of 0.1 s) and also it is capable to set the 50 % (fixed) of the applied test voltage. In addition, the fall time control function enables to decrease the test voltage gradually after the completion of a PASS judgement. The voltage fall time is fixed at 0.1 s (OFF is also selectable).

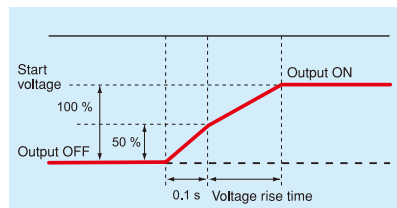

▲ Start voltage can be set at 50 % of the test voltage.

## Examples of Safety Standards (Routine Tests)

### ● IEC60950/J60950

#### - Information processing equipment

The test voltage applied to the insulation part should be increased gradually from zero to the specified voltage, then hold at the specified voltage for 60 seconds.

### ● IEC60335/J0335 - Home appliances

The initial test voltage should be applied less than half of the specified voltage, then gradually increase to the specified voltage.

### ● IEC60065/J0065 - Audio/video

The initial test voltage should be applied less than half of the specified voltage, then rapidly increase to the specified voltage and hold for 1 minute.

### ● IEC61010/JIS C 1010

#### - Measurement equipments

Avoids any detectable transient phenomenon, the test voltage should be increased gradually to the specified voltage within 5 seconds, then hold at the specified voltage for 5 seconds.

## Q & A

### Q. What is a Hipot (Withstanding voltage) test?

**A.** Withstanding test also called a dielectric strength test or Hipot test, a withstanding voltage test is intended to verify whether an electrical product or part has sufficient dielectric strength with respect to the voltage being handled.

### Q. What is PASS / FAIL criteria ?

**A.** It is considered as "Electrical breakdown" when the current exceeds the limit value flowing through the insulated section during a test. If "the Electrical breakdown" does not occur, the insulator is determined to have sufficient insulating strength.

### Q. How is the test conducted?

**A.** Apply the voltage with much higher stress than it would normally be applied to the insulated section for the specified time period. While testing, it evaluates to verify whether any insulation breakdown has occurred on the insulator.

## Interlock feature

The product is equipped with an interlock function that operates together with external devices to interrupt output. To ensure the safe operation of tester, the interlock function activates when the SIGNAL I/O connector pins number 1 and 13 are opened, and when they are short-circuited, the interlock function is released.

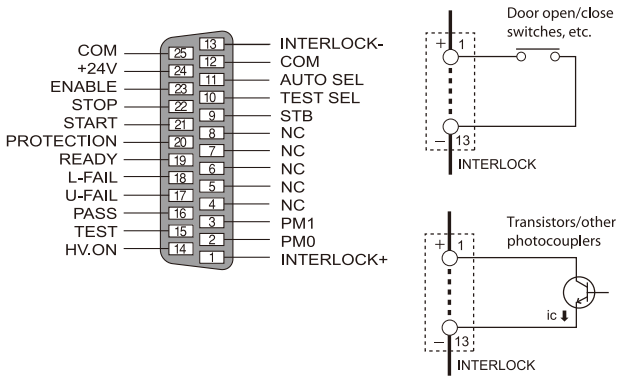

▲The picture shown above indicates the caution sign of "HI VOLTAGE DANGER" with a chain surrounding the test site.

## Discharge feature (Model TOS5301 / TOS5302)

Equipped with a forced discharge function that forcibly discharge the electricity which has been charged in the EUT after the completion of DC Hipot (Withstanding voltage) test or insulation resistance test.

## Q & A

### Q.What is an insulation resistance test?

**A.** An insulation resistance test is to measure the resistance value of insulator and verify that whether the insulator has a sufficient performance. It is similar to the Hipot (Withstanding voltage) test that confirms the function or performance of an insulator, and it should be the required conditions to prevent the accidents from an electrical shock and fire.

### Q.What is the procedure of testing?

**A.** In many cases, after moisture is absorbed (or is not absorbed in some cases), 500 volts or other specified value of DC voltage is applied, and the resistance value is measured from the current flowing.

### Q.What is the difference between an insulation resistance test and a Hipot test?

**A.** The Hipot (Withstanding voltage) test detects a faulty insulation whether insulation breakdown occurs. In contrast, the insulation resistance test detects faulty insulation by measuring the resistance value.

## Upper limits / Lower limits setting function

It automatically detects connector lead breaks and disconnections of wiring by measuring extremely small amounts of current that flows when voltage is applied to the EUT.

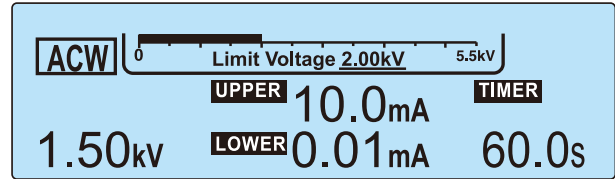

▲Example setting display of Upper limit, Lower limit, and Test time

## POINT

Normally, even with a good-quality EUT, a certain degree of leakage current flows. If the current value is set at slightly smaller than the specific range of the EUT, it is useful in detecting breaks of the test lead and faulty connections, which enables tests to be performed with even higher reliability. You can perform testing effectively if you set the lower limit value with LOWER ON during Hipot (Withstanding voltage) test, and the upper limit value with UPPER ON during insulation resistance test.

## Calibration due notice and Warning function

To assure the traceability of periodic calibration of the product, this function gives a notice of calibration due managed by the built-in real-time clock. Even if the due data has elapsed, it is possible to avoid the oversight of operator with limiting the operation with a display of warning message.

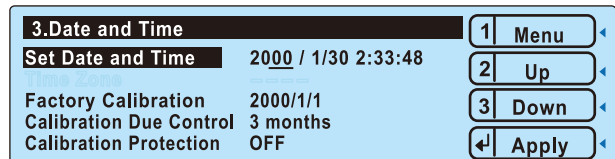

▲Example setting display of Calibration due

## Easy setting of test conditions with panel memory feature!



To set the test conditions such as test voltage, judgment value and test duration, simply press a key and turn the knob on the front panel. The test conditions can be saved in the panel memory (3 sets).

◀ Panel memory setting key

(Model TOS5302)

## AUTO TEST feature for consecutive testing

The TOS5302 can perform an AC Hipot (Withstanding voltage) test and an insulation resistance test consecutively.

Either of the following can be conducted :

Insulation resistance test → AC Hipot (Withstanding voltage) test, or  
AC Hipot (Withstanding voltage) test → Insulation resistance test.

AUTO FUNC	VOLTAGE	UPPER	LOWER	TIMER
IR	25V	OFF	OFF	0.3s
ACW	1.50kV	10.0mA	OFF	60.0s

▲ Insulation resistance test → AC withstand-voltage test

AUTO FUNC	VOLTAGE	UPPER	LOWER	TIMER
ACW	1.50kV	0.02mA	OFF	60.0s
IR	25V	OFF	OFF	0.3s

▲ AC withstand-voltage test → Insulation resistance test

## REMOTE connector & USB interface



Equipped with the REMOTE connector and USB interface on the front panel are exclusive use for the options. Easy connection with the PC.

## SIGNAL I/O Connector

The rear panel is equipped with SIGNAL I/O that provides functions such as start and stop operation and signal output.

PIN No	Signal name	I/O	TOS5300	TOS5301	TOS5302	
1	INTERLOCK+	I	If you open the positive and negative terminals, the output is turned off, and the TOS5300 Series is switched to Protection mode. Open: The resistance between the two terminals is 1.2 kΩ or greater. Short: The resistance between the two terminals is 1 kΩ or less.			
2	PM0	I	Panel memory selection signal. The selection signal is latched on the rising edge of the input strobe signal to recall panel memory. * The selection of memory is prioritized over TEST SEL and AUTO SEL.			
3	PM1	I				
				PM0	PM1	Called Panel Memory Number
				H	H	Memory 1
				L	H	Memory 2
				H	L	Memory 3
				L	L	Enables TEST SEL and AUTO SEL selection
4	NC	—	—			
5	NC	—	—			
6	NC	—	—			
7	NC	—	—			
8	NC	—	—			
9	STB	I	Panel memory's strobe signal input terminal			
10	TEST SEL	I	NA	ACW/DCW selection signal L: ACW H: DCW	Single/Independent test's selection signal/AUTO Test's sequence selection signal Selection of single test with AUTO SEL L: ACW; H: DCW Selection of AUTO test with AUTO SEL L: ACW → IR H: IR → ACW	
11	AUTO SEL	I	NA	NA	Selection of AUTO test/single test L: Single test H: AUTO test	
12	COM	—	Circuit's common terminal			
13	INTERLOCK-	I	When + terminal and - terminal are opened, output is interrupted and the system shifts to the Protection status. Open: Terminal-to-terminal resistance is 1.2 kΩ or more Short: Terminal-to-terminal resistance is 1.2 kΩ or less			
14	HV.ON	O	ON during test and while voltage remains between output terminals		ON during test, while voltage remains between output terminals, and during automatic test (AUTO TEST)	
15	TEST	O	ON during test (except when voltage is rising or falling)			
16	PASS	O	ON for at least 0.2 sec. when PASS has been determined (PASS HOLD time) Continuously ON when PASS HOLD time is set for HOLD			
17	U-FAIL	O	Continuously ON when value over acceptable maximum is detected, and UPPER FAIL is determined			
18	L-FAIL	O	Continuously ON when value under acceptable minimum is detected, and LOWER FAIL is determined			
19	READY	O	ON during standby (READY status)			
20	PROTECTION	O	ON while protection function is activated (PROTECTION ON)			
21	START	I	Start signal input terminal			
22	STOP	I	Stop signal input terminal			
23	ENABLE	I	Start signal's ENABLE signal input terminal: Shifts to the Protection status when the ENABLE signal changes			
24	+24V	—	+24V internal power supply output terminal: Maximum output current 100 mA			
25	COM	—	Circuit's common terminal			

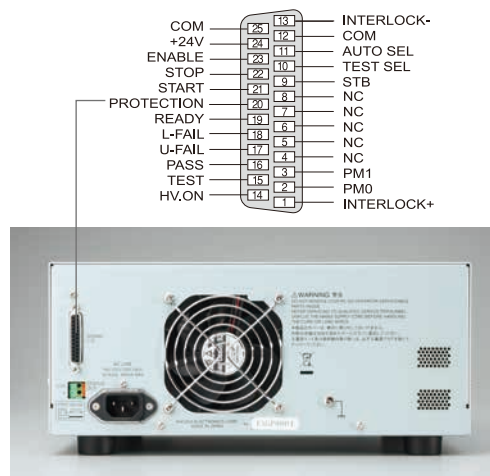

◀ Rear panel

- Unless specified otherwise, the specifications are for the following settings and conditions.
- The warm-up time is 30 minutes.
  - TYP: These are typical values. These values do not guarantee the performance of the product.
  - rdng: Indicates the readout value.
  - set: Indicates a setting.
  - f.s.: Indicates full scale.

## ■ Specifications –Withstanding voltage tester

		TOS5300	TOS5301	TOS5302	
AC output section	Output range	0.05 kV to 5.00 kV			
	Accuracy	±(2 % of set + 20 V) when no load is connected			
	Setting range	0.00 kV to 5.50 kV			
	Resolution	10 V steps			
	Max. rated output *1	500 VA (5 kV/100 mA)			
	Max. rated voltage	5 kV			
	Max. rated current	100 mA (when the output voltage is 0.5 kV or greater)			
	Transformer rating	500 VA			
	Output voltage waveform *2	Sine			
	Distortion	If the output voltage is 0.5 kV or more: 3 % or less (when no load or a pure resistive load is connected).			
	Frequency	50 Hz or 60 Hz			
	Accuracy	±0.5 % (excluding during voltage rise time)			
	Voltage regulation	10 % or less (when changing from maximum rated load to no load)			
	Input voltage variation	±0.3 % (5 kV when no load is connected; power supply voltage: 90 V to 250 V)			
Short-circuit current	200 mA or more (when the output voltage is 1.0 kV or greater)				
Output method	PWM switching				
DC output section	Output range		0.05 kV to 6.00 kV		
	Accuracy		±(2 % of set + 20 V) when no load is connected		
	Setting range		0.00 kV to 6.20 kV		
	Resolution		10 V steps		
	Max. rated output *1		50 W (5 kV/10 mA)		
	Max. rated voltage		6 kV		
	Max. rated current	—	10 mA	—	
	Ripple (TYP)	5 kV when no load is connected		50 Vp-p	
		Max. rated load		100 Vp-p	
	Voltage regulation		3 % or less (when changing from maximum rated load to no load)		
	Short-circuit current (TYP)		40 mA (when generation 6 kV output)		
Discharge feature		Forced discharge after test completion (discharge resistance: 125 kΩ)			
Start Voltage	The voltage at the start of withstanding voltage tests can be set to 50% of the test voltage.				
Limit Voltage	The test voltage upper limit can be set . AC: 0.00 kV to 5.50 kV, DC: 0.00 kV to 6.20 kV				
Output voltage monitor feature	If output voltage exceeds the specified value + 350 V or is lower than the specified value - 350 V, output is turned off, and protective features are activated.				
Voltmeter	Analog	Scale	6 kV AC/DC f.s		
		Accuracy	±5 % f.s		
		Indication	Mean-value response/rms scale		
	Digital	Measurement range	0.000 kV to 6.500 kV AC/DC		
		Display	□.□□□ kV		
		Accuracy	V < 500 V: ±(1.5 % of rdng + 20 V); V ≥ 500 V: ±1.5 % of rdng		
Response *3	True rms/ Mean-value response rms display Can be switched				
Hold feature	After a test is finished, the measured voltage is retained until the PASS or FAIL judgment is cleared.				
Ammeter	Digital	Measurement range	AC: 0.00 mA to 110 mA	AC: 0.00 mA to 110 mA DC: 0.00 mA to 11 mA	AC: 0.00 mA to 110 mA
		Display	i = measured current		
	Accuracy *4	1.00 mA ≤ i: ±(1.5 % of rdng); i < 1.00 mA: ±(1.5 % of rdng + 30 μA)			
	Response *3	True rms/ Mean-value response rms display Can be switched			
	Hold feature	After a test is finished, the measured voltage is retained until the PASS judgment is cleared.			



## ■ Specifications –Withstanding voltage tester

		TOS5300	TOS5301	TOS5302																				
Judgment feature	Judgment method and judgment operation	<table border="1"> <thead> <tr> <th>Judgment</th> <th>Judgment method</th> <th>Display</th> <th>Buzzer</th> <th>SIGNAL I/O</th> </tr> </thead> <tbody> <tr> <td>UPPER FAIL</td> <td>If a current that is greater than or equal to the upper limit is detected, the output is turned off, and an UPPER FAIL judgment occurs. During the voltage rise time (Rise Time) of DC withstanding voltage tests, an UPPER FAIL judgment also occurs if there is a problem with the voltage rise ratio.</td> <td>FAIL LED lights OVER is displayed on the screen</td> <td>ON</td> <td>Generates a U-FAIL signal</td> </tr> <tr> <td>LOWER FAIL</td> <td>If a current that is less than or equal to the lower limit is detected, the output is turned off, and a LOWER FAIL judgment occurs. This judgment is not performed during voltage rise time (Rise Time) of all tests and during the voltage fall time (Fall Time) of AC withstanding voltage tests.</td> <td>FAIL LED lights UNDER is displayed on the screen</td> <td>ON</td> <td>Generates a L-FAIL signal</td> </tr> <tr> <td>PASS</td> <td>If the specified time elapses without any problems, the output is turned off, and a PASS judgment occurs.</td> <td>PASS LED lights</td> <td>ON</td> <td>Generates a PASS signal</td> </tr> </tbody> </table>	Judgment	Judgment method	Display	Buzzer	SIGNAL I/O	UPPER FAIL	If a current that is greater than or equal to the upper limit is detected, the output is turned off, and an UPPER FAIL judgment occurs. During the voltage rise time (Rise Time) of DC withstanding voltage tests, an UPPER FAIL judgment also occurs if there is a problem with the voltage rise ratio.	FAIL LED lights OVER is displayed on the screen	ON	Generates a U-FAIL signal	LOWER FAIL	If a current that is less than or equal to the lower limit is detected, the output is turned off, and a LOWER FAIL judgment occurs. This judgment is not performed during voltage rise time (Rise Time) of all tests and during the voltage fall time (Fall Time) of AC withstanding voltage tests.	FAIL LED lights UNDER is displayed on the screen	ON	Generates a L-FAIL signal	PASS	If the specified time elapses without any problems, the output is turned off, and a PASS judgment occurs.	PASS LED lights	ON	Generates a PASS signal		
		Judgment	Judgment method	Display	Buzzer	SIGNAL I/O																		
		UPPER FAIL	If a current that is greater than or equal to the upper limit is detected, the output is turned off, and an UPPER FAIL judgment occurs. During the voltage rise time (Rise Time) of DC withstanding voltage tests, an UPPER FAIL judgment also occurs if there is a problem with the voltage rise ratio.	FAIL LED lights OVER is displayed on the screen	ON	Generates a U-FAIL signal																		
	LOWER FAIL	If a current that is less than or equal to the lower limit is detected, the output is turned off, and a LOWER FAIL judgment occurs. This judgment is not performed during voltage rise time (Rise Time) of all tests and during the voltage fall time (Fall Time) of AC withstanding voltage tests.	FAIL LED lights UNDER is displayed on the screen	ON	Generates a L-FAIL signal																			
	PASS	If the specified time elapses without any problems, the output is turned off, and a PASS judgment occurs.	PASS LED lights	ON	Generates a PASS signal																			
	<ul style="list-style-type: none"> <li>If PASS HOLD is enabled, the PASS signal is generated continuously until the TOS5300 Series receives a STOP signal.</li> <li>The UPPER FAIL and LOWER FAIL signals are generated continuously until the TOS5300 Series receives a STOP signal.</li> <li>The FAIL and PASS buzzer volume levels can be changed.</li> <li>For PASS judgments, the length of time that the buzzer sounds for is fixed to 0.2 seconds. Even if PASS HOLD is enabled, the buzzer turns off after 0.2 seconds.</li> </ul>																							
Upper limit setting	AC: 0.01 mA to 110 mA	AC: 0.01 mA to 110 mA DC: 0.01 mA to 11 mA	AC: 0.01 mA to 110 mA																					
Lower limit setting	AC: 0.01 mA to 110 mA / OFF	AC: 0.01 mA to 110 mA / OFF DC: 0.01 mA to 11 mA / OFF	AC: 0.01 mA to 110 mA / OFF																					
Judgment accuracy *4	1.00 mA ≤ i: ±(1.5 % of set), i < 1.00 mA: ±(1.5 % of set + 30 μA)																							
Current detection method	Calculates the current's true rms value or mean-value and compares this value with the reference value																							
Calibration	Calibrated with the rms of a sine wave using a pure resistive load																							
Time	Voltage rise time	0.1 s to 10.0 s																						
	Resolution	0.1 s																						
	Voltage fall time	0.1 s / OFF (only enabled when a PASS judgment occurs)																						
	Test time	0.1 s to 999 s, can be turned off (TIMER OFF)																						
	Resolution	0.1 s to 99.9 s: 0.1 s. 100 s to 999 s: 1 s.																						
	Accuracy	±(100 ppm + 20 ms) AC: Excluding Fall Time DC: Rise Time Add ±50 ms at 1 kV or more, Add ±100 ms at less than 1kV.																						

\*1. Regarding the output time limits:

Taking size, weight, and cost into consideration, the heat dissipation capability of the voltage generator that is used for withstanding voltage tests has been designed to be one half that of the rated output. Use the TOS5300 Series within the following limits. If you use the product in a manner that exceeds these limits, the output section may overheat, and the internal protection circuits may be activated. If this happens, stop testing, and wait until the TOS5300 Series returns to its normal temperature.

Ambient temperature	Upper limit	Pause time	Output time
t ≤ 40 °C	AC	50 mA < i ≤ 110 mA	Greater than or equal to the output time
		i ≤ 50 mA	Not necessary
	DC	5 mA < i ≤ 11 mA	Greater than or equal to the output time
		i ≤ 5 mA	Greater than or equal to the wait time (WAIT TIME)

(Output time = voltage rise time + test time + voltage fall time)

\*2. Regarding the test voltage waveform:

Waveform distortions may occur if an DUT whose capacitance is dependent on voltage (for example, an DUT that consists of ceramic capacitors) is connected as the load. However, if the test voltage is 1.5 kV, the effect of a capacitance of 1000 pF or less can be ignored. Because the product's high-voltage power supply uses the PWM switching method, if the test voltage is 500 V or less, the switching and spike noise proportions are large. The lower the test voltage, the greater the waveform is distorted.

\*3. For both True rms and Mean-value response, 50 ms or above response time is required to satisfy the measurement accuracy.

\*4. Regarding ammeter and judgment accuracy:

During AC withstanding voltage tests, current also flows in the stray capacitance of items such as the measurement leads and jigs. This current that flows in the stray capacitances is added to the current that flows in the DUT, and the sum of these currents is measured. Especially if you want to perform judgments with high sensitivity and accuracy, it is necessary to consider methods to limit the current that flows in these stray capacitances, such as by adding upper and lower limits.

Output voltage	1 kV	2 kV	3 kV	4 kV	5 kV
When using 350 mm long test leads that are suspended in air (TYP)	2 μA	4 μA	6 μA	8 μA	10 μA
When using the accessory, high test lead TL31-TOS (TYP)	16 μA	32 μA	48 μA	64 μA	80 μA

■ Specifications –Insulation resistance test section

		TOS5302				
Output section	Output voltage	25 V, 50 V, 100 V, 125 V, 250 V, 500 V, 1000 VDC (negative)				
	Accuracy	-0 %, +5 %				
	Max. rated load	1 W (-1000 V DC / 1 mA)				
	Max. rated current	1 mA				
	Ripple	1000 V when no load is connected	2 Vp-p or less			
		Max. rated load	10 Vp-p or less			
	Voltage regulation	1 % or less (when changing from maximum rated load to no load)				
	Short-circuit current	12 mA or less				
	Discharge feature	Forced discharge after test completion (discharge resistance: approx. 25 kΩ)				
	Limit voltage	The test voltage upper limit can be set : 25 V, 50 V, 100 V, 125 V, 250 V, 500 V, 1000 V				
Output voltage monitor feature	If output voltage exceeds "10 % of set + 10 V" or is lower than "-(10 % of set + 10 V)," output is turned off, and protective features are activated.					
Volt-meter	Analog	Scale	6 kV AC/DC f.s			
		Accuracy	±5 % f.s			
		Indication	Mean-value response/rms scale			
	Digital	Measurement range	0 V to -1200 V			
		Display	Measured voltage	V < 100 V	100 V ≤ V < 1000 V	1000 V ≤ V
			Display	□□ V	□□□ V	□□□□ V
Accuracy	± (1 % of rdng + 1 V)					
Resistance meter	Measurement range / measurement accuracy *5 *6	25 V	0.03 MΩ ≤ R ≤ 25 MΩ / ±(2 % of rdng + 2 digits) 25 MΩ < R ≤ 125 MΩ / ±5 % of rdng 125 MΩ < R ≤ 250 MΩ / ±10 % of rdng			
		50 V	0.05 MΩ ≤ R ≤ 50 MΩ / ±(2 % of rdng + 2 digits) 50 MΩ < R ≤ 250 MΩ / ±5 % of rdng 250 MΩ < R ≤ 500 MΩ / ±10 % of rdng			
		100 V	0.100 MΩ ≤ R ≤ 100 MΩ / ±2 % of rdng 100 MΩ < R ≤ 500 MΩ / ±5 % of rdng 500 MΩ < R ≤ 1 GΩ / ±10 % of rdng			
		125 V	0.125 MΩ ≤ R ≤ 125 MΩ / ±2 % of rdng 125 MΩ < R ≤ 625 MΩ / ±5 % of rdng 625 MΩ < R ≤ 1.25 GΩ / ±10 % of rdng			
		250 V	0.250 MΩ ≤ R ≤ 250 MΩ / ±2 % of rdng 250 MΩ < R ≤ 1.25 GΩ / ±5 % of rdng 1.25 GΩ < R ≤ 2.5 GΩ / ±10 % of rdng			
		500 V	0.50 MΩ ≤ R ≤ 500 MΩ / ±2 % of rdng 500 MΩ < R ≤ 2.5 GΩ / ±5 % of rdng 2.5 GΩ < R ≤ 5 GΩ / ±10 % of rdng			
		1000 V	1 MΩ ≤ R < 1 GΩ / ±2 % of rdng 1 GΩ ≤ R ≤ 5 GΩ / ±5 % of rdng			
	Display *6	25 kΩ ≤ R < 1.00 MΩ	1.00 MΩ ≤ R < 10.0 MΩ	10.0 MΩ ≤ R < 100 MΩ	100.0 MΩ ≤ R < 1.00 GΩ	1.00 GΩ ≤ R ≤ 9.99 GΩ
	□□□ kΩ	□ . □□ MΩ	□□ . □ MΩ	□□□ MΩ	□ . □□ GΩ	
Hold feature	After a test is finished, the measured resistance is retained until the PASS judgment is cleared.					
Current detection response speed	Can be switched between three levels: Fast, Mid, Slow					
Judgment feature	Judgment method and judgment operation	Judgment	Judgment method	Display	Buzzer	SIGNAL I/O
		UPPER FAIL	If a resistance that is greater than or equal to the upper limit is detected, the output is turned off, and an UPPER FAIL judgment occurs. This judgment is not performed during voltage rise time (Rise Time).	FAIL LED lights; OVER is displayed on the screen	ON	Generates a U-FAIL signal
		LOWER FAIL	If a resistance that is less than or equal to the lower limit is detected or if a problem occurs during the voltage rise time (Rise Time), the output is turned off, and a LOWER FAIL judgment occurs.	FAIL LED lights; UNDER is displayed on the screen	ON	Generates a L-FAIL signal
		PASS	If the specified time elapses without any problems, the output is turned off, and a PASS judgment occurs.	PASS LED lights	ON	Generates a PASS signal
		<ul style="list-style-type: none"> <li>• If PASS HOLD is enabled, the PASS signal is generated continuously until the TOS5300 Series receives a STOP signal.</li> <li>• The UPPER FAIL and LOWER FAIL signals are generated continuously until the TOS5300 Series receives a STOP signal.</li> <li>• The FAIL and PASS buzzer volume levels can be changed.</li> <li>• For PASS judgments, the length of time that the buzzer sounds for is fixed to 0.2 seconds. Even if PASS HOLD is enabled, the buzzer turns off after 0.2 seconds.</li> </ul>				
Upper limit setting range	0.03 MΩ to 5.00 GΩ					
Lower limit setting range	0.03 MΩ to 5.00 GΩ					
Judgment accuracy (the same for UPPER and LOWER)	Measurement accuracy + 2 digits Humidity: 20 %rh to 70 %rh (no condensation). No interference caused by wobbly test leads or other problems. For judgments of 200 nA or less, a test time of at least 1.0 seconds is necessary. If the current detection response speed is set to Mid, a test time of at least 0.3 seconds is necessary. If the current detection response speed is set to Slow, a test time of at least 0.5 seconds is necessary.					
Time	Voltage rise time	10 ms (TYP)				
	Test Time	0.1 s to 999 s, can be turned off (TIMER OFF)				
		Resolution	0.1 s to 99.9 s: 0.1 s. 100 s to 999 s: 1 s.			
Accuracy	± (100 ppm + 20 ms)					

\*5. Humidity: 20 %rh to 70 %rh (no condensation). No bends in the test leads. \*6. R = measured insulation resistance

## ■ Specifications –Other features / Interfaces

	TOS5300	TOS5301	TOS5302
Double action feature	Tests can only be started by pressing and releasing STOP and then pressing START within 0.5 seconds of releasing the STOP switch.		
Length of time to maintain a PASS judgment result	You can set the length of time to maintain a PASS judgment: 50 ms, 100 ms, 200 ms, 1 s, 2 s, 5 s, or HOLD.		
Momentary feature	Tests are only executed while the START switch is held down.		
Fail mode feature	This feature enables you to prevent remotely transmitted stop signals from clearing FAIL judgments and PROTECTION modes.		
Timer feature	This feature finishes tests when the specified time elapses.		
Output voltage monitor feature	If output voltage exceeds "setting + 350 V" or is lower than "setting - 350 V," the TOS5300 Series switches to PROTECTION mode, output is turned off, and testing finishes.		
Memory	Up to three sets of test conditions can be saved to memory.		
Key lock	Locks panel key operations (settings and changes).		
Protective features	Under any of the following conditions, the TOS5300 Series switches to the PROTECTION state, immediately turns output off, and stops testing. A message is displayed on the screen.		
Interlock Protection	An interlock signal has been detected.		
Power Supply Protection	An error was detected in the power supply.		
Volt Error Protection	While monitoring the output voltage, a voltage outside of the rated limits was detected. AC or DC withstanding voltage tests: $\pm 350$ V Insulation resistance test: $\pm(10\%$ of set + 10 V)		
Over Load Protection	During a withstanding voltage test, a value that is greater than or equal to the output limit power was specified. AC withstanding voltage test: 550 VA. DC withstanding voltage test: 55 VA.		
Over Heat Protection	The internal temperature of the TOS5300 Series became too high.		
Over Rating Protection	During a withstanding voltage test, the output current was generated for a length of time that exceeds the regulated time.		
Calibration Protection	The specified calibration period has elapsed.		
Remote Protection	A connection to or disconnection from the front-panel REMOTE connector was detected.		
SIGNAL I/O Protection	The rear-panel SIGNAL I/O connector's ENABLE signal has changed.		
USB Protection	The USB connector has been disconnected while the TOS5300 Series was being controlled through the USB interface.		
System clock	Set in the following format: year/month/day hour/minutes/seconds.		
Calibration date	Set when the TOS5300 Series is calibrated.		
Calibration period setting	Sets the period before the next calibration is necessary.		
Notification of when the calibration period elapses	Sets the operation that is performed when the specified calibration period elapses. When the TOS5300 Series turns on, it can display a notification or switch to the protection mode and disable testing.		
Interfaces	USB	USB Specification 2.0	
	REMOTE	Front-panel 9-pin MINI DIN connector. By connecting an optional device to this connector, you can control the starting and stopping of tests remotely.	
	SIGNAL I/O	Rear-panel D-sub 25-pin connector	

## ■ Specifications –General

	TOS5300	TOS5301	TOS5302
Display	VFD: 256 × 64 dots + 4 status indicators		
Backup battery life	3 years (at 25 °C or 77 °F)		
Environment	Installation location	Indoors, at a height of up to 2000 m	
	Spec guaranteed range	Temperature	5 °C to 35 °C (41 °F to 95 °F)
		Humidity	20 %rh to 80 %rh (no condensation)
	Operating range	Temperature	0 °C to 40 °C (32 °F to 104 °F)
		Humidity	20 %rh to 80 %rh (no condensation)
Storage range	Temperature	-20 °C to 70 °C (-4 °F to 158 °F)	
	Humidity	90 %rh or less (no condensation)	
Power supply	Nominal voltage range(allowable voltage range)	100 VAC to 240 VAC (90 VAC to 250 VAC)	
	Power consumption	When no load is connected (READY)	100 VA or less
		When rated load is connected	800 VA max.
Allowable frequency range	47 Hz to 63 Hz		
Insulation resistance (between AC LINE and the chassis)	30 M $\Omega$ or more (500 VDC)		
Withstanding voltage (between AC LINE and the chassis)	1400 VAC, 2 seconds (Routine test) / 1500 VAC, 1 minutes (Type test)		
Earth continuity	25 AAC, 0.1 $\Omega$ or less		
Safety *7	Complies with the requirements of the following directive and standard. Low Voltage Directive 2014/35/EU*8, EN 61010-1 (Class I*11, Pollution degree 2*12)		
Electromagnetic compatibility (EMC) *7 *8	Complies with the requirements of the following directive and standards. EMC Directive 2014/30/EU, EN 61326-1 (Class A*9), EN 55011 (Class A*9, Group 1*10), EN 61000-3-2, EN 61000-3-3 Applicable under the following conditions: The maximum length of all cabling and wiring connected to the TOS5300 is less than 2.5 m. Shielded cables are being used when using the SIGNAL I/O. The high-voltage test lead TL31-TOS is being used. Electrical discharges are not occurring outside the DUT.		
Dimensions	See "Outline drawing."		
Weight	Approx. 14 kg (30.9 lb.)	Approx. 15 kg (33.1 lb.)	Approx. 14 kg (30.9 lb.)
Accessories	Power cord : 1pc. / High test lead (TL31-TOS) : 1set (1 red wire and 1 black wire, each with alligator clips); 1.5 m / D-sub 25-pin plug : 1set ; assembly type / High-voltage warning sticker : 1pc. / User's manual : 1pc. / CD-R : 1pc. *9		

## ■ Outline drawing

Unit: mm (inch)

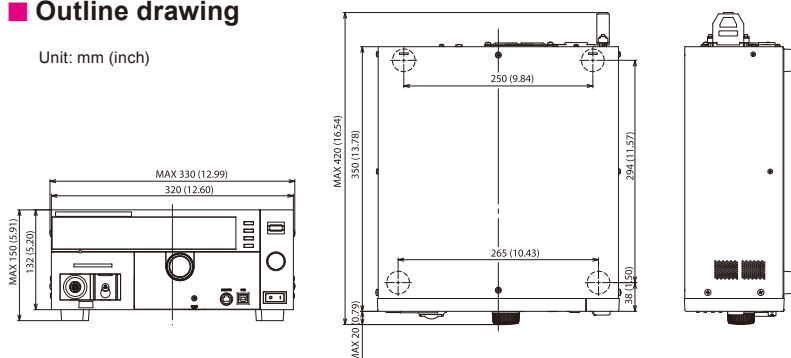

- \*7 Does not apply to specially ordered or modified TOS5300s.
- \*8 Limited to products that have the CE mark on their panels.  
Not be in compliance with EMC limits unless the ferrite core is attached on the cable for connection of J1 connector.
- \*9 This is a Class A equipment. The TOS5300 is intended for use in an industrial environment. This product may cause interference if used in residential areas. Such use must be avoided unless the user takes special measures to reduce electromagnetic emissions to prevent interference to the reception of radio and television broadcasts.
- \*10 This is a Group 1 equipment. The TOS5300 does not generate and/or use intentionally radio-frequency energy, in the form of electromagnetic radiation, inductive and/or capacitive coupling, for the treatment of material or inspection/analysis purpose.
- \*11 This is a Class I equipment. Be sure to ground the TOS5300's protective conductor terminal. The safety of this product is only guaranteed when the product is properly grounded.
- \*12 Pollution is addition of foreign matter (solid, liquid or gaseous) that may produce a reduction of dielectric strength or surface resistivity. Pollution Degree 2 assumes that only non-conductive pollution will occur except for an occasional temporary conductivity caused by condensation.

## Ordering information

Product Name	Model	Remarks
AC Hipot (Withstanding voltage) & Insulation Resistance tester (ACW/IR)	TOS5302	Hipot (Withstanding voltage) test: AC 5 kV/100 mA Insulation Resistance test: 25V - 1000V
AC/DC Hipot (Withstanding voltage) tester (ACW/DCW)	TOS5301	Hipot (Withstanding voltage) test: AC 5 kV/100 mA, DC 6 kV/50 W
AC Hipot (Withstanding voltage) tester (ACW)	TOS5300	Hipot (Withstanding voltage) test: AC 5 kV/100 mA

## Options

### Test Lead

■ TL31-TOS (Max. AC5 kV/1.5 m)

\*Standardly attached to main unit in TOS5300 Series.

■ TL32-TOS (Max. AC5 kV/3 m)

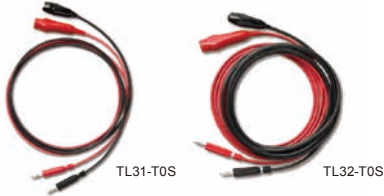

### Remote Control Box

■ RC01-TOS\* (For single-handed operation/1.5 m)

■ RC02-TOS\* (For two-handed operation/1.5 m)



\*The remote control conversion cable [DD-5P/9P] is required when used with TOS5300 Series.

### Warning Light Unit

■ PL02-TOS (for DC24 V)



### Test Probe

■ HP01A-TOS\* (Max. AC4 kV-DC5 kV/1.8 m)

■ HP02A-TOS\* (Max. AC4 kV-DC5 kV/3.5 m)



\*The remote control conversion cable [DD-5P/9P] is required when used with TOS5300 Series.

### DIN Cable

■ DD-5P/9P conversion adapter (DIN - Mini DIN)



### Rack Mount Adapter

■ KRA4-TOS (inch rack for EIA standards)

■ KRA200-TOS (millimeter rack for JIS standards)

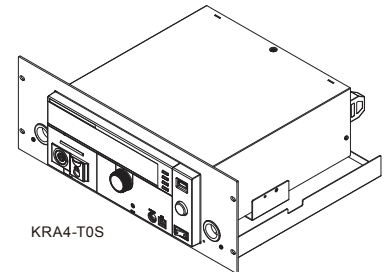

## TOS Series Electrical safety testers developed under the quality brand of KIKUSUI !!

### Electrical Safety Multi-analyzer TOS9300 Series



### Insulation Tester TOS7200



### Hipot Tester TOS5200



### Ground Bond Tester TOS6210 / 6200A



### Leakage Current Tester TOS3200



For details of the each products, please refer to the catalog "Electrical Safety Testers".



### KIKUSUI ELECTRONICS CORPORATION

Southwood 4F,6-1 Chigasaki-chuo,Tsuzuki-ku,Yokohama,224-0032,Japan  
Phone: (+81)45-482-6353, Facsimile: (+81)45-482-6261, www.kikusui.co.jp

KIKUSUI AMERICA, INC. 1-310-214-0000 [www.kikusuiamerica.com](http://www.kikusuiamerica.com)



3625 Del Amo Blvd, Suite 160, Torrance, CA 90503  
Phone: 310-214-0000 Facsimile: 310-214-0014

KIKUSUI TRADING (SHANGHAI) Co., Ltd. [www.kikusui.cn](http://www.kikusui.cn)



Room 305, Shenggao Building, No.137, Xianxia Road, Shanghai City, China  
Phone: 021-5887-9067 Facsimile: 021-5887-9069

For our local sales distributors and representatives, please refer to "sales network" of our website.

### ●Distributor/Representative

■ All products contained in this catalogue are equipment and devices that are premised on use under the supervision of qualified personnel, and are not designed or produced for home-use or use by general consumers. ■ Specifications, design and so forth are subject to change without prior notice to improve the quality. ■ Product names and prices are subject to change and production may be discontinued when necessary. ■ Product names, company names and brand names contained in this catalogue represent the respective registered trade name or trade mark. ■ Colors, textures and so forth of photographs shown in this catalogue may differ from actual products due to a limited fidelity in printing. ■ Although every effort has been made to provide the information as accurate as possible for this catalogue, certain details have unavoidably been omitted due to limitations in space. ■ If you find any misprints or errors in this catalogue, it would be appreciated if you would inform us. ■ Please contact our distributors to confirm specifications, price, accessories or anything that may be unclear when placing an order or concluding a purchasing agreement.