



# PLZ-5WH2 SERIES



DC ELECTRONIC LOAD



## Compact High Voltage DC Electronic Load **PLZ-5WH2 Series**

Operating voltage: 10 V to 1000 V (Min. 1.5 V)

Power capacity: 1 kW/2 kW/4 kW/12 kW/20 kW, 5 models

100 kW/ 2000 A with parallel operation (Max. 5 units) Connectable with 5WH series

LAN (LXI)/USB/RS232C standard digital interface \*GPIB optional

Synchronized operation

Sequence function

Arbitrary IV characteristic (ARB) mode

Data-logging: voltage/current/power measurements  
(Measurement display, programmable internal memory)



# Compact, High Power Maximum Operating Voltage 1000 V

Up to  
**100 kW**  
Max Power  
\*5 Unit Parallel

Ideal for high capacity power supply and rechargeable battery evaluation!  
Testing with hyper-realistic load simulation made possible!



The PLZ-5WH2 high power DC electronic load series is where durable, reliable ingenuity meets multifunctional and high power design. Providing 5 variety of power range line-ups, from 1 kW bench top style model to high power model that can sink up to 20 kW of power in a single unit. Possible to easily select applicable power range depends on the load. Load simulation can be achieved faster than ever before thanks to the reliable, high speed design of the PLZ-5WH current control circuits. Accurate current measures can be made with extremely high setting resolution. A color LCD display allows for highly visible, user-friendly front panel operation. RS232C, USB, and LAN digital interfaces are included as standard for simple integration into any system.

## Compact High Voltage DC Electronic Load **PLZ-5WH2 Series** NEW

- **Operating voltage:** 10 V to 1000 V (Min. 1.5 V)
- **20 kW capacity in a single, compact unit (PLZ20005WH2)**
- **Parallel operation:** 5 units (Max. 100 kW/ 2000 A), Connectable with different models.\*  
\*Connectable with 5WH series. However, a firmware update is required.
- **Synchronization:** Load on/off control and sequence execution can be synchronized among multiple units.
- **Sequence Function:** Program can be saved / loaded on USB memory
- **Arbitrary IV characteristic (ARB) mode**
- **User-friendly color LCD display**
- **Data logging function:** voltage/current/power/elapsed time/integrated current/integrated power measurements. (Measurement display, programmable internal memory, stored as CSV format onto a USB.)
- **Superposition of sinusoidal current (Sine Function, 1 Hz to 10 kHz)**
- **Cutoff function:** The load can be turned off when the elapsed time, the voltage drop, the integrated current, or the integrated power reaches the specified value.
- **LAN (LXI)/USB/RS232C standard digital interface \*GPIB optional**

Model	Max operating current	Operating voltage	Power
PLZ1005WH2	20 A	10 V to 1000 V	1 kW
PLZ2005WH2	40 A		2 kW
PLZ4005WH2	80 A		4 kW
PLZ12005WH2	240 A		12 kW
PLZ20005WH2	400 A		20 kW

## Operation Modes

[Specifications: See P.8-9]

The following five operation modes are available on the PLZ-5WH2. In addition, available to set in operation modes other than CV mode, the "UVPL" setting keep the voltage less than UVP setting by controlling the current and the "UVPT" setting loads off by applying a current to reach the target setting voltage.

<b>Constant current (CC) mode</b>	When a current value is specified, the current is kept at that value even when the voltage changes.
<b>Constant resistance (CR) mode</b>	When a conductance value is specified, the product sinks current proportional to the voltage variation by using the value as a proportionality constant.
<b>Constant voltage (CV) mode</b>	When a voltage value is specified, the product runs the current so that the voltage is kept at that value.
<b>Constant power (CP) mode</b>	When a power value is specified, the product runs the current so that the power is kept at that value.
<b>Arbitrary I-V characteristics (ARB) mode</b>	The desired load characteristics can be set by specifying multiple arbitrary voltage values and current values as I-V characteristics.

\*"UVPL" is the "+CV mode" in PLZ-5W series

## Arbitrary I-V Characteristics (ARB) Mode

[Specifications: See P.9]

In ARB mode, arbitrary I-V characteristics can be set by registering multiple I-V characteristic points (pairs of voltage and current values). Three up to 100 points can be registered, and the space between two points is linearly interpolated. The minimum voltage (0.00 V) and current (0.00 A) and the maximum voltage (1010.00 V) and current (1010.00 A) are fixed.

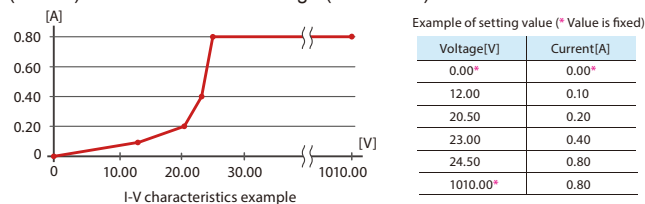

## Maximum Slew Rate of 20 A/μs

[Specifications: See P.10]

The PLZ-5WH2 series boasts a 20 μs rise time\*, easily satisfying the critical needs of power supply evaluation tests demanding a fast transient response. \*When using the PLZ20005WH2

PLZ20005WH2 Slew Rate: 20 A/μs

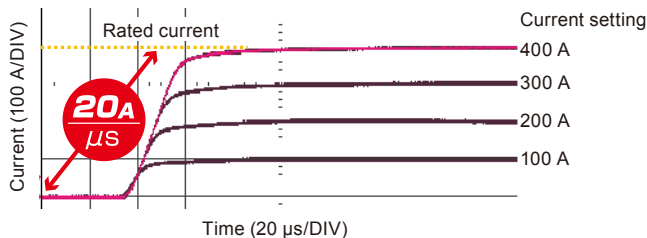

## Wide Ranging Operation Voltage up to 1000 V

Operating voltage ranges from 10 V to 1000 V. Minimum operating voltage required to sink current is 1.5 V.

[Operating area of PLZ20005WH2]

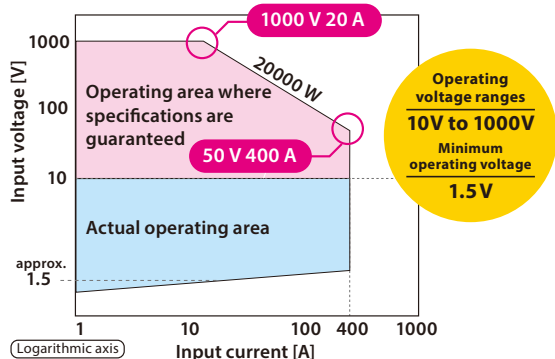

## Parallel Operation

### Up to 100 kW with parallel operation (Max. 5 units)

Parallel operation (max. 5 units) is available on all models by simply connecting an optional parallel operation cable. This feature is available even among different models for a wide range of high power. (up to 100 kW / 2000 A)

\*A parallel cable needs to have each unit connection. 12 kW and 20 kW models are included in accessory. 1 kW, 2 kW and 4 kW models are option.

#### ● Connection conceptual diagram

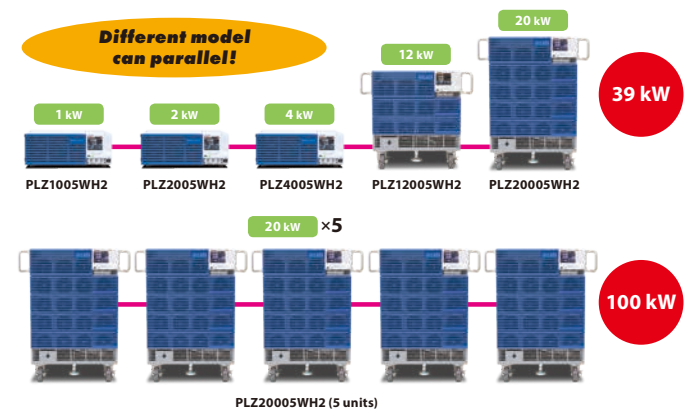
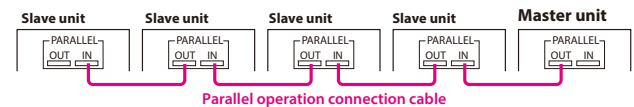

#### ● Parallel connection with PLZ-5WH series\*

Must be PLZ-5WH as a Master and update the firmware to newest version. \*When parallel operation between 5WH and 5WH2, only same capacity model is available.

#### ● Maximum current and power during parallel operation using the same model

Model	Parallel operation number	Maximum current	Maximum power
PLZ20005WH2	2	800 A	40 kW
	3	1200 A	60 kW
	4	1600 A	80 kW
	5	2000 A	100 kW

## Communication Interface

[Specifications: See P.12]

LAN, USB and RS232C standard digital interface. \*GPIB Option



Use a browser from a PC, smartphone, or tablet to access the web server built into the PLZ-5WH2 series for convenient control and monitoring.

#### [Recommended browser]

- Microsoft Edge 10
- Internet Explorer version 9.0 or later
- Firefox 8.0 or later
- Safari/Mobile Safari 5.1 or later
- Chrome 15.0 or later
- Opera 11.0 or later

\*Connecting with a smartphone, tablet, etc. requires a Wi-Fi environment. (wireless LAN router etc.)

## Load On/Off

The following load on/off settings are available in addition to standard operations that can be carefully adjusted to fit the needs of any test environment.

- Start with "load on" when power is turned on
- Display elapsed "load on" time
- Auto "load off" when time limit is reached
- Control "load on/off" with external controls such as relays
- "Load off" by specifying conditions (Cutoff function)

## Cutoff Function

[Specifications: See P.11]

The cutoff function allows the user to enable load off once the elapsed time/voltage drop/integrated current/integrated power has been reached after load on. Multiple factors can be selected, with load off being implemented after the first requirement is met.

Elapsed time	The load turns off when the elapsed time value reaches the specified value.
Voltage drop*	The load turns off when the voltmeter value reaches the specified value.
Integrated current	The load turns off when the ampere-hour meter value reaches the specified value.
Integrated power	The load turns off when the watt-hour meter value reaches the specified value.

\*Voltage drop cutoff operates in the same manner as UVPT of the UVP function. UVP turns the load off based on the protection function, but the cutoff function turns the load off when the specified conditions are met. As such, there is no need to clear alarms, which is required when a UVPT is activated.

## Changing the Response Speed

Set the response speed for CV, CR, or ARB mode according to the DUT's conditions and application.

Item	Description
Voltage	Set the response speed for CV mode. Normal, Fast
	Conductance Set the response speed for CR mode. Normal, Fast
Response	Set the response speed for ARB mode. The value is the filter response time. Select OFF for no filter.
	ARB OFF, 500 $\mu$ s, 1 ms, 2 ms, 5 ms, 10 ms, 20 ms, 50 ms, 100 ms

## Soft Start

Soft start is a function that controls the rise time of the load current. Soft start functions only when all the following conditions are met.

- The rise time of the soft start has been set.
- Load on state in constant current (CC) mode.
- There is an input that is equal to or exceeds the minimum operating condition, from the state where there is no input to the load input terminals.

If the load current rises sharply, the DUT output may become unstable or the DUT's overcurrent protection circuit may be activated. In such situations, it is possible to make the load current to rise slowly only when the product is started.

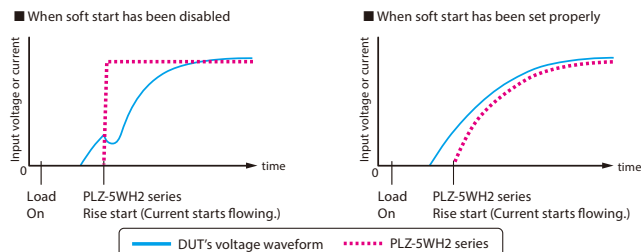

Operation mode	CC
Time setting range	500 $\mu$ s, 1 ms, 2 ms, 5 ms, 10 ms, 20 ms, 50 ms, 100 ms, or off

## Data Logging Function

[Specifications: See P.9]

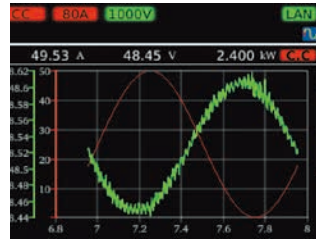

▲ Data logging display example (Figure display)

The data logging function allows the user to log measurement values (current, voltage, power) in the internal memory, and display logged data on an LCD screen (Table) as a chart (Chart). By setting measurement recording conditions, you can control the timing that measurements are recorded.

Condition	Value	Description
Trigger	-	Set the measurement recording timing and the number of times to record measurements.
	-	Event (trigger source) that defines the measurement recording condition. Recording starts after the Initiate key is pressed and a trigger is received.
Source	Immediate	Pressing Initiate applies a trigger immediately.
	BUS	Applies a trigger when a *TRG command is received from a PC or when the *TRG key on the front panel is pressed.
	DIGITAL2*	Applies a trigger when a signal is received at pin 13 of the EXT CONT connector.
	MSync	The trigger application timing is synced between PLZ-5WH2 that are synchronized
	TALink	Applies a trigger when a step is executed if Generate is set to TALink in the sequence step settings
	Load Off	Applies a trigger when the load is turned off.
Count	1 to 65536	The number of times to recorded measurements.
Delay	0 $\mu$ s to 100 s (resolution: 10 $\mu$ s)	The delay time from trigger application until measurement recording.
Interval	Disable/Enable	Sets whether to insert an interval between recordings when Count is 2 or higher.
Interval Time	10 $\mu$ s to 3600 s (resolution: 10 $\mu$ s)	Recording interval time when Interval is set to Enable.
Sense Aperture	10 $\mu$ s to 1 s (resolution: 10 $\mu$ s)	Time period of each recording. The average over the time period is recorded.

\*Only when Direction of Digital 2 is set to Input

## Integrated Data Function

[Specifications: See P.11]

Time elapsed, integrated current and integrated power can be logged. Logging (integration) can be coordinated to start/finish when the load turns on/off or during the start or end of a sequence. Logging can also be controlled arbitrarily.

Item	Value	Description
Integral Gate	-	Set the integrated data recording period.
	None	Integrated data recording is started/stopped manually.
	Load On	Recording is started/stopped automatically in synchronization with load on/load off. Or, recording is started or stopped manually.
Program Run	-	Recording is started/stopped automatically in synchronization with sequence execution start/stop. Or, recording is started or stopped manually.
	-	Selects the integrated data reset method. If the product is restarted, inte-grated data is reset.
Reset	Manual	Integrated data is reset when the Reset key is pressed.
	Auto	Integrated data is automatically reset before the start of recordings. Or, integrated data is reset when the Reset key is pressed.

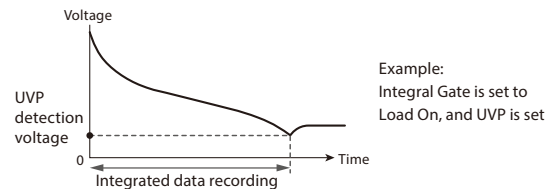

## Saving Measurement Data

Measurement data can be stored in CSV format to a USB memory device.

## Pulse Function

[Specifications: See P.9]

Pulse function refers to the operation of executing two settings repetitively. It is suitable for transient response characteristics testing of large capacity power supplies and batteries. When the pulse operation is in progress, a trigger signal is output from the TRIG OUT connector on the front panel. You can set this regardless of whether the load is on or off. This function operates in CC and CR modes. The pulse amplitude is set with a value or a percentage of the load value.

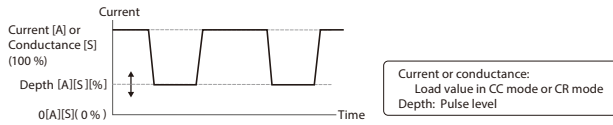

When the pulse operation is in progress, a trigger signal is output for 10 μs from the TRIG OUT connector on the front panel when the current amplitude changes from low (Depth) to high (Set) level.

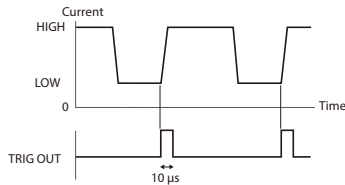

Operation mode		CC and CR
Frequency setting range		1.0 Hz to 10.0 kHz
Frequency setting resolution*	1 Hz to 10 Hz	0.1 Hz
	11 Hz to 100 Hz	1 Hz
	110 Hz to 1000 Hz	10 Hz
	1.1 kHz to 10.0 kHz	0.1 kHz

\* (Reference) The resolution actually set in the device is period resolution  $\Delta T = 1 \mu s$ , as shown in the equation below. For example, if you specify 9300 Hz, the period set in the device will be  $n \times \Delta T = 108 \times 1 \mu s = 108 \mu s$  (where n is a number set in the device). Converted to frequency, this becomes  $1/108 \mu s = 9259 \text{ Hz}$ .

## Sine Function

The sine function varies the current sinusoidally. It is suitable for superposed ripple testing of large capacity power supplies and batteries. When a sine operation is in progress, a trigger signal is output from the TRIG OUT connector on the front panel. You can set this regardless of whether the load is on or off. This function operates in CC mode. You cannot set the slew rate. Set the sine amplitude with a value.

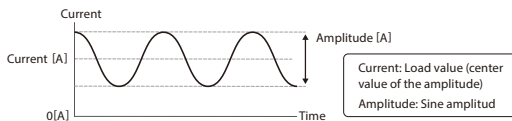

When a sine operation is in progress, a trigger signal is output for 10 μs from the TRIG OUT connector on the front panel when the current passes through the Set value on the rising edge (sine wave phase at 0 degrees).

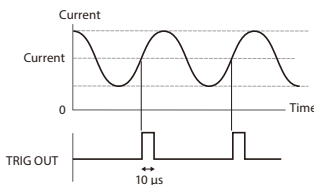

Operation mode		CC
Frequency setting range		1 Hz to 1 kHz, 2 kHz, 5 kHz, 10 kHz
Frequency setting resolution*	1 Hz to 10 Hz	1 Hz
	20 Hz to 100 Hz	10 Hz
	200 Hz to 1000 Hz	100 Hz
	1000 Hz to	2 kHz, 5 kHz, 10 kHz

\* (Reference) The resolution actually set in the device is period resolution  $\Delta T = 20 \mu s$ , as shown in the equation below. For example, if you specify 900 Hz, the period set in the device will be  $n \times \Delta T = 56 \times 20 \mu s = 1120 \mu s$  (where n is a number set in the device). Converted to frequency, this becomes  $1/1120 \mu s = 893 \text{ Hz}$ .

## Sequence Function

A sequence consists of programs and steps. A program is a collection of steps. Steps are executed in order one at a time, starting from step 1. The completion of the last step signifies that the program has been executed once. When the specified number of program loops is completed, the sequence ends. You can set the load state (load on or off, load value, slew rate) at the end of the sequence of a program.

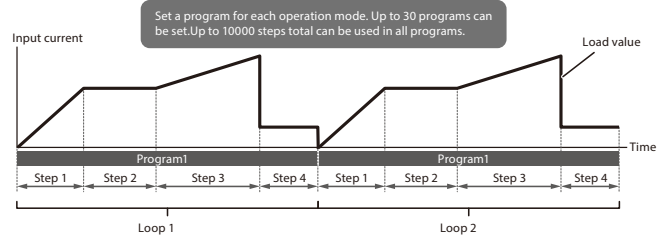

Setting range	Setting	Description
By step	Load value	Current, conductance, voltage, power. The values that can be set depend on the current operation mode.
	Slew rate	Sets the speed of change when the current is changed.
	Step execution time	0.000050 s to 3600000 s (50 μs to 1000 h), resolution: 1 μs
	Load on/off control	To turn the load on, set the load setting transition method to step or ramp.
For each program	Other	Trigger signal setting, trigger signal output
	Number of loops of program	1 to 100000 repetitions, or infinite repetitions.
	Protection function	Specifies the value at which a protection function (OCP, OPP, UVP) is activated.

### TALink

The TALink (Transient Acquire Link) trigger makes it possible to log data in PLZ-5WH2 in synchronization with the sequence steps. Logged data can then be accessed through communication with the PLZ-5WH2 and saved to a USB as a CSV file.

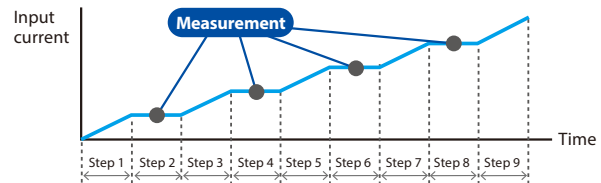

## Alarm Function

[Specifications: See P.10]

This function detects anomalies and protects the DUT. There are two types of alarm based on urgency level: alarm 1 (high urgency) and alarm 2 (low urgency).

### Alarm 1 (high urgency)

Name	Activation
Overvoltage detection (OVP)	
Reverse-connection detection (Reverse)	
Overheat detection, overcurrent detection of the front-panel DC INPUT terminals (OTP/Front)	Load off
Alarm input detection (External)	
Parallel operation anomaly detection	

### Alarm 2 (low urgency)

Name	Mode	Activation
Overcurrent protection (OCP)	CR, CV, CP	Load off or limit
Overpower protection (OPP)	CC, CR, CV, ARB	
Undervoltage protection (UVP)	CC, CR, CP, ARB	Load off, limit, or activation off
Watchdog protection (WDP)	All	Load off

This function limits the current (UVPL) or turns off the load (UVPT) when the voltage applied to the product becomes equal to or less than the UVP setting. You can set this regardless of whether the load is on or off.

Trip	Turns the load off. The setting display changes to UVPT.
Limit	Limits the voltage so as not to become equal to or less than the set value. The setting display changes to UVPL.

## ABC Preset Memories

Three setting values can be stored in preset memory slots A, B, and C. All saved settings can be accessed at the press of a button, which is perfect for when you want to quickly switch between three sets of values.

## Setup Memory

The setup memory can store up to 20 sets (0 to 19) of the current conditions of the items listed below. The current conditions can also be saved in a USB memory device.

- Operation mode
- Load values (current, voltage, conductance, power)
- Slew rate
- Pulse amplitude (current/conductance or percentage)
- Pulse interval (frequency/time of one cycle and duty cycle/operating time on the high side)
- Sine amplitude (current)
- Sine frequency
- Alarm operating conditions
- Content of ABC preset memories

A file saved on the PLZ-5WH2 can be transferred to the PLZ-5W via a USB memory device. If the UVP is set to "limit" on the PLZ-5WH2, this will be changed to +CV mode on the PLZ-5W (PLZ205W, PLZ405W, PLZ1205W).

## External Control

[Specifications: See P.12]

The PLZ-5WH2 can be controlled and monitored from an external device. The external control terminals are isolated from the load input terminal.

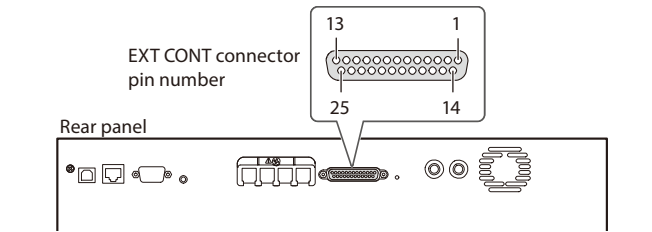

Pin no.	In/Out *1	Signal name	Description
1	-	STATUS COM	Status signal common for pins 14 to 16.
2	NC	-	-
3	NC	-	-
4	NC	-	-
5	IN	ALARM CLEAR	Alarm clearing input
6	IN	ALARM INPUT	Alarm input
7	NC	-	-
8	NC	-	-
9	IN	TRIG INPUT	Trigger input. Resumes program execution if Wait(post) is set to Trig IN in a sequence step and the program was paused.
10	-	A COM	This is connected to the chassis.
11	OUT	DIGITAL 0	DIGITAL0 output. Sequence control possible.
12	OUT	DIGITAL 1	DIGITAL1 output. Sequence control possible.
13	IN/OUT	DIGITAL 2	DIGITAL2 I/O. Input/output switchable. Sequence signal output or the trigger input of sequences and measurement function.
14	OUT	ALARM1	ALARM1 output. ON when overvoltage detection, reverse-connection detection, overheat detection, alarm input detection, or parallel operation anomaly detection is activated, and also during external alarm input.
15	OUT	ALARM2	ALARM2 output. ON during OCP, OPP, UVP, or WDP operation.
16	OUT	LOAD ON STATUS	Load-on status output. ON during load on.
17	NC	-	-
18	IN	LOAD ON/OFF CONT	Load on/off control input. Logic level switchable.
19	-	A COM	This is connected to the chassis.
20	IN	EXT CONT ADD	External voltage control input. Controls the load setting of CC mode by adding current.
21	IN	EXT CONT MODE	External voltage control input. Controls the load values of CC, CR, and CP modes.
22	IN	EXT CONT CV	External voltage control input. Controls the voltage of CV mode.
23	-	A COM	This is connected to the chassis.
24	OUT	IMON	Current monitor output.
25	NC	-	-

\*1 1000 V reinforced insulation between each terminal and the DC INPUT terminal.

## Current and Voltage Monitor

[Specifications: See P.12]



In addition to the conventional current monitor output, voltage monitor output (0 V to 10 V/Output of 1/100 of measured voltage) has been added to the front BNC connector.

## USB Keyboard

You can enter numbers/characters if you connect a keyboard to the USB port on the front panel.

The types of keyboards that you can use are 101-key and 104-key keyboards.

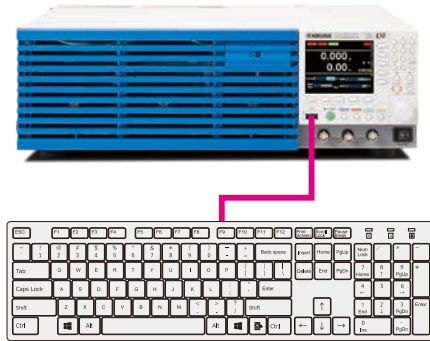

## Synchronized Operation

The following synchronization features are available when simply connecting the PLZ-5WH2 with other equipment using a communication cable. Any of the models in the PLZ-5WH2 series can be connected together. Synchronized operation is possible even during parallel operation.

- Synchronizing load on/off among multiple pieces of equipment.
- Synchronizing measurements.
- Synchronizing the start time and resume time for sequences across multiple units.

[Connection example]

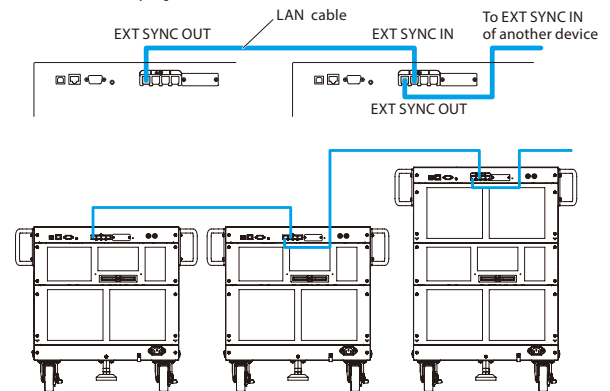

## Remote Sensing

With remote sensing, the voltage measurement point can be changed from the load input terminal to the DUT sensing point. By connecting the sensing leads to the DUT, the effects of voltage drops caused by resistance in the load cables can be reduced and the operation in CR / CV / CP / ARB mode stabilized.

- Remote sensing input rated voltage: 1000 V

## ● Battery Discharge Testing

Battery discharge test can be conducted and results saved without a PC. The acquired data can be saved in CSV format on USB memory.

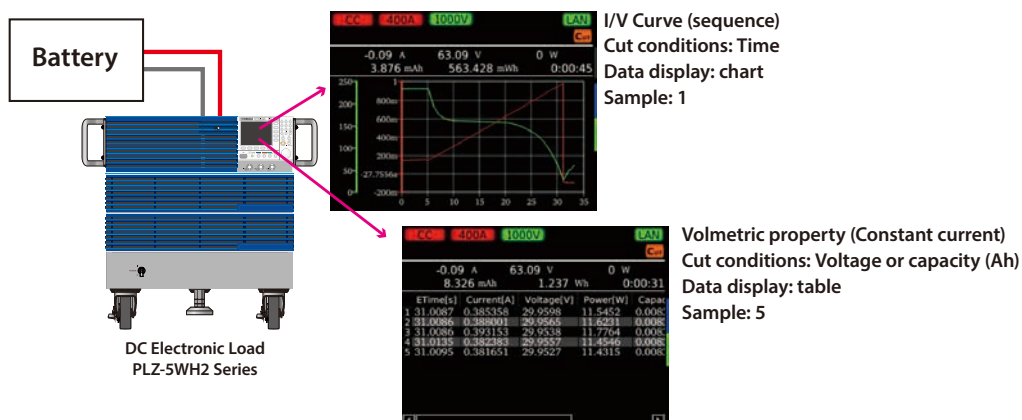

## ● EV Charger Aging Tests

LV124 Standard L-02 Life test - high-temperature endurance test (Durability - Heat) [Life test]

[Combination of AC power source and electronic load equipment]

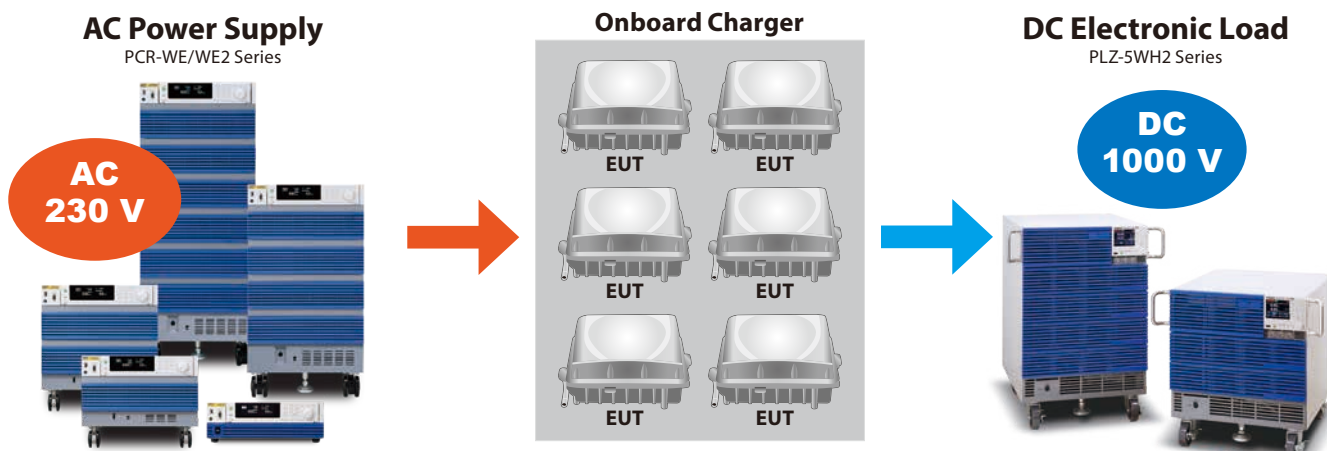

\*DUT must function completely before/during/after testing (n=6 units)

## ● DC-DC Converter Evaluation

DC-DC converter performance tests vital for automotive electric components can easily be carried out by controlling the converter input (DC power supply) and output (DC electronic load). The DC power supply and electronic load can be started up simultaneously for variation tests and efficiency tests.

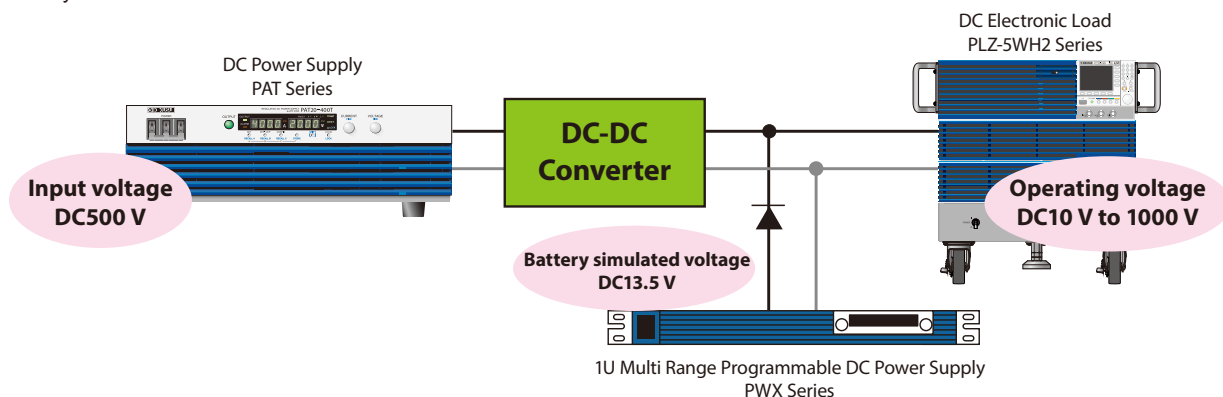

Unless specified otherwise, the specifications are for the following settings and conditions.

- The product is warmed up for at least 30 minutes.
- Rear-panel DC INPUT terminals are used.

The used terminology is as follows:

- TYP: These are typical values that are representative of situations where the product operates in an environment with an ambient temperature of 23 °C (73.4 °F). These values do not guarantee the performance of this product.
- setting: Indicates a setting.
- reading: Indicates a readout value.
- rating: Indicates a rated value.
- Open: Indicates equivalence to the state in which the DC INPUT terminals are opened.

## Rating

Item	PLZ1005WH2	PLZ2005WH2	PLZ4005WH2	PLZ12005WH2	PLZ20005WH2
Operating voltage (DC)	10 V to 1000 V				
Power	1000 W	2000 W	4000 W	12000 W	20000 W
Current	20 A	40 A	80 A	240 A	400 A
DC INPUT terminal's isolation voltage	Positive pin: ±1000 V, Negative pin: ±900 V				
Minimum operating voltage	At the rated current	10 V			
	When the current begins to flow	1.5 V or less			

## Constant current (CC) mode

Item	PLZ1005WH2	PLZ2005WH2	PLZ4005WH2	PLZ12005WH2	PLZ20005WH2
Operating range	0 A to 20 A	0 A to 40 A	0 A to 80 A	0 A to 240 A	0 A to 400 A
Setting range	0.0000 A to 20.2000 A	0.000 A to 40.400 A	0.000 A to 80.800 A	0.00 A to 242.40 A	0.00 A to 404.00 A
Resolution	0.0005 A	0.001 A	0.002 A	0.005 A	0.01 A
Setting accuracy	±(0.2 % of setting + 0.1 % of rating)				
	Parallel operation	±(0.4 % of setting + 0.2 % of rating)			

## Constant resistance (CR) mode

Item	PLZ1005WH2	PLZ2005WH2	PLZ4005WH2	PLZ12005WH2	PLZ20005WH2	
Operating range *1	H range	500 mS to 0 S	1 S to 0 S	2 S to 0 S	6 S to 0 S	10 S to 0 S
	L range	5 mS to 0 S	10 mS to 0 S	20 mS to 0 S	60 mS to 0 S	100 mS to 0 S
Setting range	H range	505.00 mS to 0.00 S	1.01000 S to 0.00000 S	2.02000 S to 0.00000 S	6.0600 S to 0.00000 S	10.1000 S to 0.0000 S
	L range	5.0500 mS to 0.0000 S	10.1000 mS to 0.0000 S	20.2000 mS to 0.000 S	60.600 mS to 0.000 S	101.000 mS to 0.000 S
Resolution	H range	0.01 mS	0.00002 S	0.00005 S	0.0002 S	0.0002 S
	L range	0.0001 mS	0.0002 mS	0.0005 mS	0.002 mS	0.002 mS
Setting accuracy *2	H range	±(0.5 % of setting + 0.5 % of rating *3)				
	L range	±(0.5 % of setting + 0.2 % of rating *3)				
	Parallel operation	H range	±(1.0 % of setting + 1.0 % of rating *3)			
		L range	±(1.0 % of setting + 0.4 % of rating *3)			
Response speed	NORM/FAST					

\*1. Conductance [S] = input current [A]/input voltage [V] = 1/resistance [Ω]

\*2. Converted value at the input current. At the sensing point during remote sensing.

\*3. Rated current

## Constant voltage (CV) mode

Item	PLZ1005WH2	PLZ2005WH2	PLZ4005WH2	PLZ12005WH2	PLZ20005WH2
Operating range	10 V to 1000 V				
Setting range	0.00 V to 1010.00 V				
Resolution	0.02 V				
Setting accuracy *1	±(0.05 % of setting + 0.05 % of rating)				
	Parallel operation	±(0.1 % of setting + 0.1 % of rating)			
Response speed	NORM/FAST				

\*1. With the input voltage within the operating range, and at the sensing point during remote sensing.

## Constant power (CP) mode

Item	PLZ1005WH2	PLZ2005WH2	PLZ4005WH2
Operating range	0 W to 1000 W	0 W to 2000 W	0 W to 4000 W
Setting range	0.00 W to 1010.00 W	0.00 W to 2020.00 W	0 W to 4040.00 W
Resolution	0.02 W	0.05 W	0.1 W
Setting accuracy	±(0.5 % of rating *1 + 0.02 A × Vin *2)	±(0.5 % of rating *1 + 0.04 A × Vin *2)	±(0.5 % of rating *1 + 0.08 A × Vin *2)
	Parallel operation	±(1 % of power rating + 0.1 % current rating × Vin *2)	

Item	PLZ12005WH2	PLZ20005WH2
Operating range	0 W to 12000 W	0 W to 20000 W
Setting range	0.0000 kW to 12.1200 kW	0.0000 kW to 20.2000 kW
Resolution	0.0005 kW	
Setting accuracy	±(0.5 % of rating *1 + 0.2 A × Vin *2)	±(0.5 % of rating *1 + 0.4 A × Vin *2)
	Parallel operation	±(1 % of power rating + 0.1 % current rating × Vin *2)

\*1. Rated power

\*2. DC INPUT terminal voltage or SENSING terminal voltage.



### ■Arbitrary I-V characteristics (ARB) mode

Item	PLZ1005WH2	PLZ2005WH2	PLZ4005WH2	PLZ12005WH2	PLZ20005WH2
Operating range	Three to 100 points of current values can be specified for the input voltage. Linear interpolation is applied between specified points.				
Response speed	500 $\mu$ s, 1 ms, 2 ms, 5 ms, 10 ms, 20 ms, 50 ms, 100 ms, or off				

### ■Measurement function

#### Voltmeter

Item	PLZ1005WH2	PLZ2005WH2	PLZ4005WH2	PLZ12005WH2	PLZ20005WH2
Display	0.00 V to 1000.00 V				
Resolution	10 mV				
Accuracy	$\pm(0.05\%$ of reading + 0.05 % of rating)				
Parallel operation	$\pm(0.1\%$ of reading + 0.1 % of rating) (TYP)				

#### Ammeter

Item	PLZ1005WH2	PLZ2005WH2	PLZ4005WH2	PLZ12005WH2	PLZ20005WH2
Display	0.000 A to 20.000 A	0.000 A to 40.000 A	0.000 A to 80.000 A	0.00 A to 240.00 A	0.00 A to 400.00 A
Resolution	0.001 A	0.001 A	0.001 A	0.01 A	0.01 A
Accuracy	$\pm(0.2\%$ of reading + 0.1 % of rating)				
Parallel operation	$\pm(0.4\%$ of reading + 0.2 % of rating) (TYP)				

#### Power display

Item	PLZ1005WH2	PLZ2005WH2	PLZ4005WH2	PLZ12005WH2	PLZ20005WH2
Display	Displays the product of the voltmeter reading and ammeter reading				

#### Measurement trigger

Item	PLZ1005WH2	PLZ2005WH2	PLZ4005WH2	PLZ12005WH2	PLZ20005WH2
Trigger Source	Immediate, BUS, DIGITAL2, MSync, TALink, LoadOff				
Trigger Count	1 to 65536				
Trigger Delay	0.00000 s to 100.00000 s				
Interval	Disable/Enable				
Interval Time	0.00001 s to 3600 s				
Sense Aperture	0.00001 s to 1.00000 s				

### ■Pulse function

Item	PLZ1005WH2	PLZ2005WH2	PLZ4005WH2	PLZ12005WH2	PLZ20005WH2
Operation mode	CC and CR				
Frequency setting range	1.0 Hz to 10.0 kHz				
Frequency setting resolution *1	1 Hz to 10 Hz	0.1 Hz			
	11 Hz to 100 Hz	1 Hz			
	110 Hz to 1000 Hz	10 Hz			
	1.1 kHz to 10.0 kHz	0.1 kHz			
Frequency setting accuracy	1 Hz to 5.0 kHz	$\pm(0.5\%$ of setting)			
	5.1 Hz to 10.0 kHz	$\pm(1.0\%$ of setting)			
Duty cycle setting range, step	1 Hz to 10 Hz	5.0 % to 95.0 %, 0.1 % steps			
	11 Hz to 100 Hz				
	110 Hz to 1000 Hz	5 % to 95 % *2, 1 % steps			
	1.1 kHz to 10.0 kHz				

\*1. (Reference) The resolution actually set in the device is period resolution  $\Delta T = 1 \mu$ s, as shown in the equation below. For example, if you specify 9300 Hz, the period set in the device will be  $n \times \Delta T = 108 \times 1 \mu$ s = 108  $\mu$ s (where n is a number set in the device). Converted to frequency, this becomes  $1/108 \mu$ s = 9259 Hz.

\*2. The minimum time span is 20  $\mu$ s. The minimum duty cycle is limited by the minimum time span.

#### Switch value (Depth)

Item *1	PLZ1005WH2	PLZ2005WH2	PLZ4005WH2	PLZ12005WH2	PLZ20005WH2	
CC mode	0.0000 A to 20.2000 A	0.000 A to 40.400 A	0.000 A to 80.800 A	0.000 A to 242.40 A	0.00 A to 404.00 A	
CR mode	H range	505.00 mS to 0.00 S	1010.00 mS to 0.00 S	2020.00 mS to 0.00 S	6.06000 S to 0.00000 S	10.1000 S to 0.0000 S
	L range	5.0500 mS to 0.0000 S	10.1000 mS to 0.0000 S	20.2000 mS to 0.0000 S	60.600 mS to 0.000 S	101.000 mS to 0.000 S

\*1. The switch value is limited to the set current or set conductance or less.

■ Slew rate

Item	PLZ1005WH2	PLZ2005WH2	PLZ4005WH2	PLZ12005WH2	PLZ20005WH2
Operation mode	CC				
Operating range	0.001 A/μs to 1 A/μs	0.002 A/μs to 2 A/μs	0.004 A/μs to 4 A/μs	0.01 A/μs to 12 A/μs	0.02 A/μs to 20 A/μs
Resolution	0.00002 A/μs	0.00005 A/μs	0.0001 A/μs	0.0002 A/μs	0.0005 A/μs
Setting accuracy *1	±(10 % of setting +20 μs)				

\*1. Time to change from 10 % to 90 % when the current is changed from 0 % to 100 % of the rated current

■ Sine function

Item	PLZ1005WH2	PLZ2005WH2	PLZ4005WH2	PLZ12005WH2	PLZ20005WH2
Operation mode	CC				
Frequency setting range	1 Hz to 1000 Hz, 2000 Hz, 5000 Hz, 10000 Hz				
Frequency setting resolution *1	1 Hz to 10 Hz	1 Hz			
	20 Hz to 100 Hz	10 Hz			
	200 Hz to 1000 Hz	100 Hz			
	1000 Hz to	2 kHz, 5 kHz, 10 kHz			
Frequency setting accuracy	300 Hz to 900 Hz	±(1.0 % of setting)			
	Other than the frequencies above	±(0.5 % of setting)			

\*1. (Reference) The resolution actually set in the device is period resolution  $\Delta T = 20 \mu s$ , as shown in the equation below. For example, if you specify 900 Hz, the period set in the device will be  $n \times \Delta T = 56 \times 20 \mu s = 1120 \mu s$  (where n is a number set in the device). Converted to frequency, this becomes  $1/1120 \mu s \approx 893 \text{ Hz}$ .

■ Soft start

Item	PLZ1005WH2	PLZ2005WH2	PLZ4005WH2	PLZ12005WH2	PLZ20005WH2
Operation mode	CC				
Time setting range	500 μs, 1 ms, 2 ms, 5 ms, 10 ms, 20 ms, 50 ms, 100 ms, or off				

■ Alarm function

Alarm 1

Item	PLZ1005WH2	PLZ2005WH2	PLZ4005WH2	PLZ12005WH2	PLZ20005WH2
Overvoltage detection	Turns off the load when a voltage that is 110 % of the rating or higher is applied.				
Reverse-connection detection	Turns off the load when approximately -1 % of the rated current flows through the DC INPUT terminals.				
Overheat detection, overcurrent detection of the front-panel DC INPUT terminals	Turns off the load when the heatsink temperature reaches 100 °C. Or, turns off the load when a current of 30 A or higher is flowing through the front-panel DC INPUT terminals.				
Alarm input detection	Turns off the load when a voltage between 0 V and 1.5 V is applied to ALARM INPUT (pin 6) of the EXT CONT connector.				
Parallel operation anomaly detection	Turns off the load when any of the following errors occurs. <ul style="list-style-type: none"> <li>• An error occurred in the communication between the master unit and slave unit during parallel operation.</li> <li>• A slave unit's power supply was interrupted.</li> <li>• An overheating was detected on the master or slave unit.</li> <li>• An overcurrent flowed through the front-panel DC INPUT terminals.</li> <li>• PLZ-5WH series or PLZ-5W series was connected as a slave.</li> </ul>				

Alarm 2

Item	PLZ1005WH2	PLZ2005WH2	PLZ4005WH2	PLZ12005WH2	PLZ20005WH2	
Overcurrent protection (OCP)	Setting range	0.000 A to 22.000 A	0.00 A to 44.00A	0.00 A to 88.00A	0.00 A to 264.00A	0.00 A to 440.00A
	Resolution	0.001 A	0.01 A	0.01 A	0.01 A	0.1 A
	Protection operation	Select load off or limit.				
Overpower protection (OPP)	Setting range	0.0 W to 1100.0 W	0.0 W to 2200.00 W	0 W to 4400 W	0.000 W to 13.200 kW	0.000 W to 22.000 kW
	Resolution	0.1 W	0.1 W	1 W	0.001 kW	0.001 kW
	Protection operation	Select load off or limit.				
Undervoltage protection (UVP)	Setting range	0.00 V to 1000.00 V, or off.				
	Resolution	0.02 V				
	Protection operation	Select load off or limit.				
Watchdog protection (WDP)	Setting range	1 s to 3600 s or off				
	Protection operation	Load off				

■ Sequence function

Item	PLZ1005WH2	PLZ2005WH2	PLZ4005WH2	PLZ12005WH2	PLZ20005WH2
Operation mode	CC, CR, CV, CP				
Maximum number of programs	30				
Maximum number of steps	10000				
Step execution time	0.000050 s to 3600000 s (50 μs to 1000 h)				
Time resolution	1 μs				

### ■ Integration display

Item	PLZ1005WH2	PLZ2005WH2	PLZ4005WH2	PLZ12005WH2	PLZ20005WH2
Elapsed time display	Displays the time from load on to load off.				
Range	0 s to 3600000 s (1000 h 0 min 0 s)				
Ampere-hour meter display	Displays integrated current				
Range	0 Ah to 70000 Ah	0 Ah to 140000 Ah	0 Ah to 280000 Ah	0 Ah to 800000 Ah	0 Ah to 1400000 Ah
Watt-hour meter display	Displays integrated power				
Range	0 Wh to 40000000 Wh	0 Wh to 80000000 Wh	0 Wh to 160000000 Wh	0 Wh to 500000000 Wh	0 Wh to 800000000 Wh

### ■ Cutoff function

Item	PLZ1005WH2	PLZ2005WH2	PLZ4005WH2	PLZ12005WH2	PLZ20005WH2
Elapsed time	The load turns off when the elapsed time value reaches the specified value.				
Range	0 s to 3600000 s (1000 h 0 min 0 s)				
Resolution	1 s				
Integrated current	The load turns off when the ampere-hour meter value reaches the specified value.				
Range	0 Ah to 70000 Ah	0 Ah to 140000 Ah	0 Ah to 280000 Ah	0 Ah to 800000 Ah	0 Ah to 1400000 Ah
Resolution	0.001 mAh (0.000 mAh to 1000.000 mAh) 0.001 Ah (1.001 Ah to 1000.000 Ah) 0.001 kAh (1.001 kAh to 1 000.000 kAh) 0.001 MAh (1.001 MAh to 1.400 MAh)				
Integrated power	The load turns off when the watt-hour meter value reaches the specified value.				
Range	0 Wh to 40000000 Wh	0 Wh to 80000000 Wh	0 Wh to 160000000 Wh	0 Wh to 500000000 Wh	0 Wh to 800000000 Wh
Resolution	0.001 Wh (0.000 Wh to 1 000.000 Wh) 0.001 kWh (1.001 kWh to 1 000.000 kWh) 0.001 MWh (1.001 MWh to 800.000 MWh)				
Voltage drop	The load turns off when the voltmeter value becomes less than or equal to the specified value.				
Range	0.00 V to 1000.00 V				
Resolution	0.02 V				

### ■ Other functions

Item	PLZ1005WH2	PLZ2005WH2	PLZ4005WH2	PLZ12005WH2	PLZ20005WH2
Remote sensing	Input voltage rating *1	1000 V *2			
	Isolation voltage	±1000 V			
Number of units in parallel operation	5 units				
Mutual synchronized operation *3	Synchronizes load on/off. Synchronization of sequence execution, and sequence resumption. Synchronizing the recording timing of measured values.				

\*1. There are limitations depending on the actual power that the load consumes.

\*2. Total potential difference between the DC INPUT terminals and SENSING terminals

\*3. The terminals for mutual synchronized operation are isolated from the DC INPUT terminals and operate at the chassis potential.

■EXT CONT connector

Item *1	PLZ1005WH2	PLZ2005WH2	PLZ4005WH2	PLZ12005WH2	PLZ20005WH2
Load on/off control input	Logic level switchable. Pulled up to 5 V by a 10 kΩ resistor. The thresholds are HIGH: 3.5 V to 5 V, LOW: 0 V to 1.5 V.				
Alarm input	An alarm is activated with a voltage between 0 V and 1.5 V. Pulled up to 5 V by a 10 kΩ resistor. The thresholds are HIGH: 3.5 V to 5 V, LOW: 0 V to 1.5 V.				
Alarm clearing input	After an alarm occurs, eliminate the root cause of the alarm, and change the input to pin 5 of the EXT CONT connector from a low level signal to a high level signal. The alarm will be cleared on the rising edge of this signal. Pulled up to 5 V by a 10 kΩ resistor. The thresholds are HIGH: 3.5 V to 5.0 V, LOW: 0 V to 1.5 V.				
Trigger input	Paused sequence operation resumes when a voltage between 0 V and 0.66 V is received. Pulled up to 5 V by a 10 kΩ resistor. The thresholds are HIGH: 2.31 V to 3.3 V, LOW: 0 V to 0.66 V.				
External voltage control input(CC, CR, CP mode)	Controls the load settings of CC, CR, CP mode through external voltage input. Input impedance: Approx. 10 kΩ. CC: The setting can be controlled in the range of 0 % to 100 % of the rated current through external voltage input of 0 V to 10 V. CR: The setting can be controlled in the range of 0 % to 100 % of the conductance setting through external voltage input of 0 V to 10 V. CP: The setting can be controlled in the range of 0 % to 100 % of the rated power through external voltage input of 0 V to 10 V.				
Setting accuracy	±(1 % of rating) (TYP value in CC mode)				
External voltage control input (CV mode)	The load setting of CV mode can be controlled through external voltage input. The rated voltage can be controlled in the range of 0 % to 100 % with 0 V to 10 V. Input impedance: Approx. 10 kΩ.				
Setting accuracy	±(1 % of rating) (TYP)				
External voltage control input (superimposing in CC mode)	Controls the load setting of CC mode by adding current through external voltage input. Adds current in the range of -100 % to 100 % of the rated current for -10 V to 10 V. Input impedance: Approx. 10 kΩ.				
Setting accuracy	±(1 % of rating) (TYP)				
Load-on status output	On when load is on. Open-collector output from a photocoupler. *2				
ALARM 1 output	ON when overvoltage detection, reverse-connection detection, overheat detection, front-panel DC INPUT overcurrent detection, alarm input detection, or parallel operation anomaly detection is activated. Open-collector output from a photocoupler. *2				
ALARM 2 output	Turns on when OCP, OPP, UVP, or WDP is activated. Open-collector output from a photocoupler. *2				
DIGITAL 0 output	Can be controlled through sequences. Output impedance: Approx. 330 Ω. The thresholds are HIGH: 2.5 V to 3.3 V, LOW: 0 V to 0.4 V.				
DIGITAL 1 output					
DIGITAL 2 input/output	Input/output switchable. Output: Sequence trigger output. The output impedance is 330 Ω. The thresholds are HIGH: 2.5 V to 3.3 V, LOW: 0 V to 0.4 V. Input: Trigger input signal for the sequence and the measurement functions. The thresholds are HIGH: 2.31 V to 3.3 V, LOW: 0 V to 0.66 V				
Current monitor output	Outputs 0 V to 10 V for 0 % to 100 % of the rated current. Output impedance: 1 kΩ (TYP).				
Accuracy	±(1 % of rating) (TYP)				

\*1. 1000 V reinforced insulation between each terminal and the DC INPUT terminal

\*2. The maximum voltage that can be applied to the photocoupler is 30 V. The maximum current is 4 mA.

■BNC connector

Item	PLZ1005WH2	PLZ2005WH2	PLZ4005WH2	PLZ12005WH2	PLZ20005WH2
Trigger output	Transmits 10 μs pulses during step execution when trigger output is set in a sequence. Transmits 10 μs pulses during pulse operation and sine operation. Output impedance: 200 Ω, output voltage HIGH: 4.2 V to 5.0 V, LOW: 0 V to 0.4 V.				
Current monitor output	Output voltage	Outputs 0 V to 10 V for 0 % to 100 % of the rated current			
	Output impedance	50 Ω (TYP)			
	Accuracy	±(1 % of rating)			
Voltage monitor output	Output voltage	Outputs the measured voltage with 1/100 magnification from 0 V to 10 V.			
	Output impedance	50 Ω (TYP)			
	Accuracy	±(1 % of rating)			
Isolation voltage	±30 V				

■Communication function

Item	PLZ1005WH2	PLZ2005WH2	PLZ4005WH2	PLZ12005WH2	PLZ20005WH2
RS232C	Hardware	D-SUB 9-pin connector. Baud rate: 9600, 19200, 38400, 115200 bps. Data length: 8 bits, Stop bits: 1 bit, Parity bit: None Flow control: No, CTS/RTS			
	Message terminator	LF during reception, LF during transmission.			
USB (device)	Hardware	Standard type B socket. Complies with the USB 2.0 specification. Data rate: 480 Mbps (High Speed).			
	Message terminator	LF or EOM during reception, LF + EOM during transmission.			
	Device class	Complies with the USBTMC-USB488 device class specifications.			
USB (host)	Hardware	Standard type A socket Complies with the USB 2.0 specification. Data rate: 480 Mbps (High Speed).			
LAN	Hardware	IEEE 802.3 100Base-TX/10Base-T Ethernet IPv4, RJ-45 connector.			
	Compliant standards	LXI 1.4 Core Specification 2011			
	Communication protocol	VXI-11, HiSLIP, SCPI-RAW, SCPI-Telnet			
	Message terminator	VXI-11, HiSLIP: LF or END during reception, LF + END during transmission. SCPI-RAW: LF during reception, LF during transmission.			

## ■ General specifications

Item	PLZ1005WH2	PLZ2005WH2	PLZ4005WH2	PLZ12005WH2	PLZ20005WH2
Input voltage range	100 Vac to 240 Vac (90 Vac to 250 Vac) single phase				
Input frequency range	47 Hz to 63 Hz				
Power consumption	70 VAmax	90 VAmax	150 VAmax	360 VAmax	590 VAmax
Inrush current (peak value)	100 Vac	30 Amax	30 Amax	30 Amax	40 Amax
	230 Vac	80 Amax	80 Amax	80 Amax	160 Amax
Leakage current *1	0.5 mA or less	0.6 mA or less	0.8 mA or less	1.6 mA or less	2.4 mA or less
Environmental conditions	Operating temperature range	0 °C to 40 °C (32 °F to 104 °F)			
	Operating humidity range	20 %rh to 85 %rh (no condensation)			
	Storage temperature range	-25 °C to 60 °C (-13 °F to 140 °F)			
	Storage humidity range	90 %rh or less (no condensation)			
	Installation location	Indoor use, altitude of up to 2000 m, overvoltage category II			
Insulation resistance	Between primary and chassis, input, monitor terminals	1000 Vdc, 30 MΩ or more (70 %rh or less)			
	Between input terminals and chassis, monitor terminal	1000 Vdc, 3 MΩ or more (70 %rh or less)			
Withstanding voltage	Between primary and chassis, input, monitor terminals	No abnormalities at 1500 Vac for 2 s			
	Between input terminals and chassis, monitor terminal	No abnormalities at 1500 Vac for 2 s			
External dimensions	Refer to external dimensions				
Weight	Approx. 13 kg (28.7 lbs)	Approx. 16 kg (35.3 lbs)	Approx. 20 kg (44.1 lbs)	Approx. 64 kg (141.1 lbs)	Approx. 93 kg (205 lbs)
Accessories	<p><b>[Common to all models]</b>            Power cord (1 pc., length: 2.5 m), Safety terminal adapter TL41 (red 1 set, black 1set), External control connector kit (1 set), Safety Information (1 copy), Setup Guide (1 copy), Quick Reference (Japanese 1 sheet, English 1 sheet), CD-ROM (1 disc)</p> <p><b>[PLZ1005WH2, PLZ2005WH2, PLZ4005WH2]</b>            Rear-panel DC INPUT terminal cover (1 set), Screw set for rear-panel DC INPUT terminals (2 sets), Screws for the rear-panel DC INPUT terminal cover (2 pcs.), Front-panel DC INPUT terminal cover (1 pc.), Screws for the front-panel DC INPUT terminals (2 pcs.), Heavy object warning label (1 pc.) PLZ4005WH2 only</p> <p><b>[PLZ12005WH2, PLZ20005WH2]</b>            Rear-panel DC INPUT terminals cover (1 set), Screw set for rear-panel DC INPUT terminals (2 sets), Rear-panel DC INPUT terminals cover screws (2 pcs.), Heavy object warning label (1 pc.), Parallel operation signal cable kit [PC02-PLZ-5W]</p>				
Electromagnetic compatibility (EMC) *2 *3	Complies with the requirements of the following directive and standards. EMC Directive 2014/30/EU EN 61326-1 (Class A *4), EN 55011 (Class A *4, Group 1 *5), EN 61000-3-2, EN 61000-3-3 Applicable under the following conditions The maximum length of all cabling and wiring connected to the product must be less than 3 m.				
Safety *2	Complies with the requirements of the following directive and standards. EMC Directive 2014/35/EU *3 EN 61010-1 (Class I *6, Pollution Degree 2 *7)				

\*1. Leakage current between the positive and negative terminals of the rear-panel DC INPUT. At 1000 Vdc.

\*2. Does not apply to specially ordered or modified products.

\*3. Limited to models that have a CE mark on their panels.

\*4. This is a Class A instrument. This product is intended for use in an industrial environment. This product may cause interference if used in residential areas. Such use must be avoided unless the user takes special measures to reduce electromagnetic emissions to prevent interference to the reception of radio and television broadcasts.

\*5. This is a Group 1 instrument. This product does not generate and/or use intentionally radio-frequency energy, in the form of electromagnetic radiation, inductive and/or capacitive coupling, for the treatment of material or inspection/analysis purpose.

\*6. This is a Class I instrument. Be sure to ground this product's protective conductor terminal.

The safety of this product is guaranteed only when the product is properly grounded.

\*7. Pollution is addition of foreign matter (solid, liquid or gaseous) that may produce a reduction of dielectric strength or surface resistivity.

Pollution Degree 2 assumes that only non-conductive pollution will occur except for an occasional temporary conductivity caused by condensation.

● **PLZ1005WH2/PLZ2005WH2**

429.5(16.91)(MAX455(17.91))W×128(5.04)(MAX145(5.71))H×400(15.75)(MAX540(21.26))D (mm (inch))

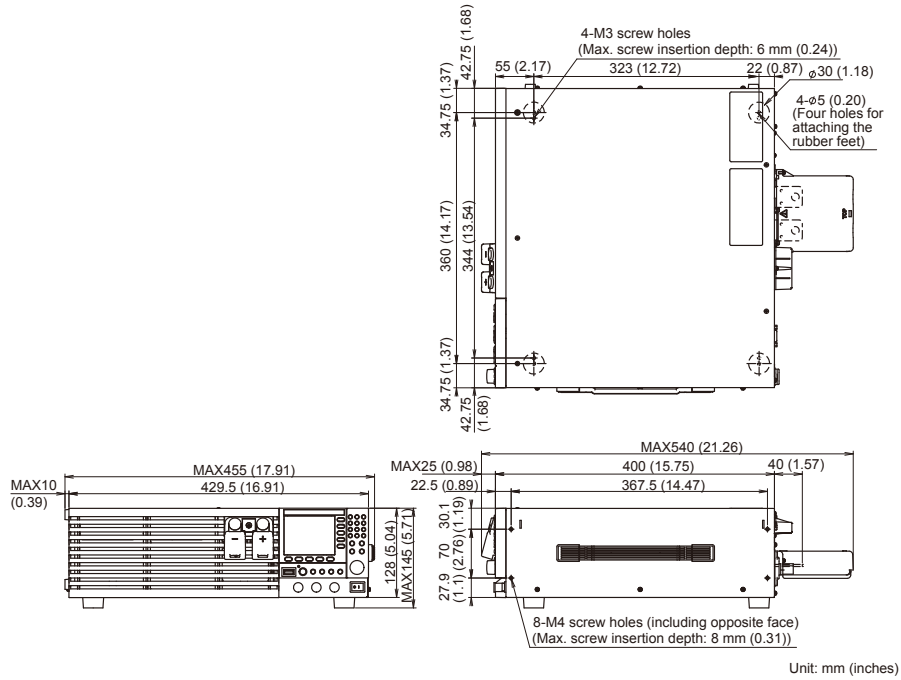

● **PLZ4005WH2**

429.5(16.91)(MAX440(17.32))W×128(5.04)(MAX145(5.71))H×500(19.69)(MAX640(25.2))D (mm (inch))

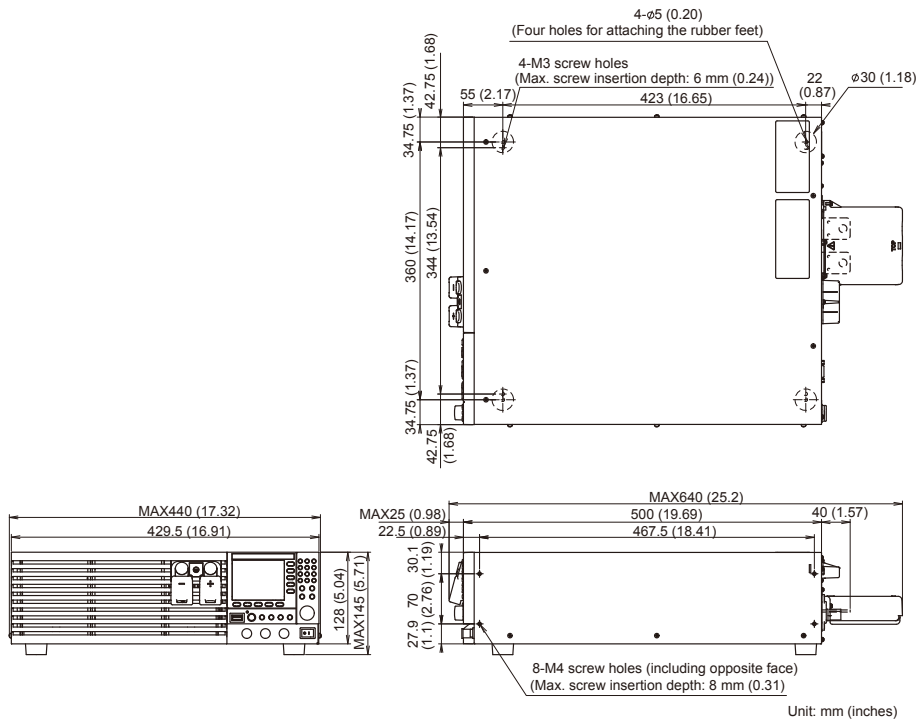

● **PLZ12005WH2**

430(16.93)(MAX545(21.46))W×396.2(15.6)(MAX495(19.49))H×550(21.65)(MAX720(28.35))D (mm (inch))

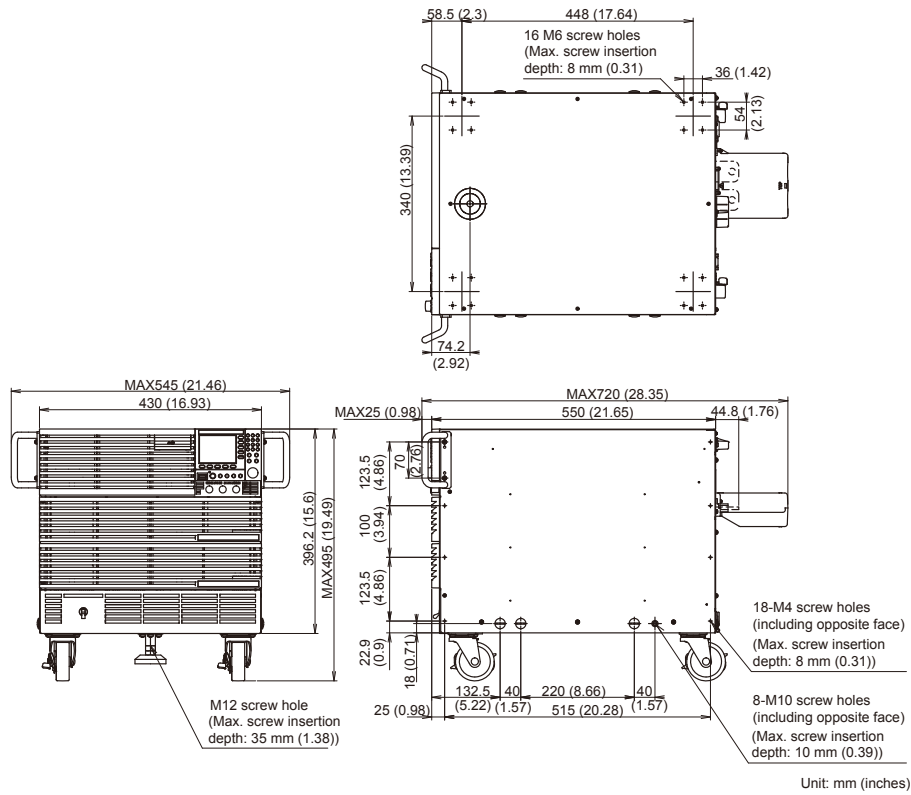

● **PLZ20005WH2**

430(16.93)(MAX545(21.46))W×573.5(22.58)(MAX670(26.38))H×550(21.65)(MAX720(28.35))D (mm (inch))

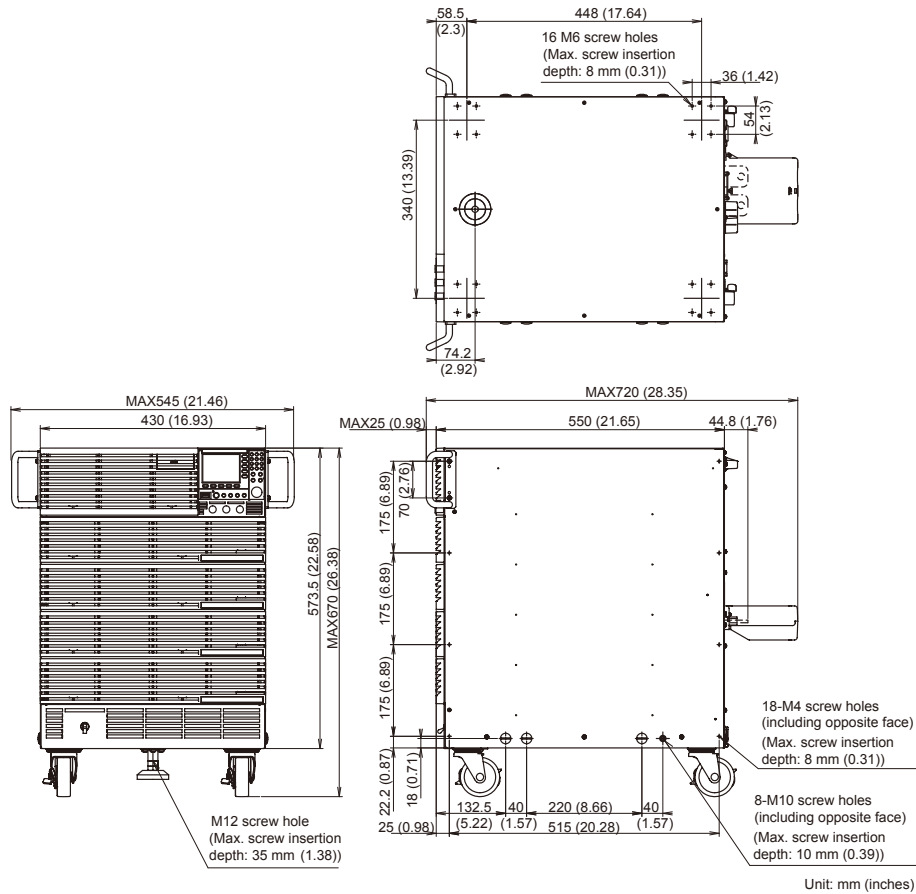

## Parallel Operation Signal Cable Kit

One cable required for each slave/booster unit.

Name	Model	Cable length
Parallel operation cable	PC01-PLZ-5W	Approx. 30 cm
	PC02-PLZ-5W*	Approx. 1 m

\* Supplied with PLZ12005WH2 and PLZ20005WH2.

## High-Voltage Load Cable Coming soon

This load cable supports high voltage.  
Up to 80 A (Kikusui-recommended current) is supported.

## Rack Mount Bracket

These are rack mounting options.

Model	Appropriate Model	Description
KRB3-TOS	PLZ1005WH2 PLZ2005WH2 PLZ4005WH2	For EIA inch racks
KRB150-TOS		For JIS millimeter racks
KRB9	PLZ12005WH2	For EIA inch racks
KRB400-PCR-LE		For JIS millimeter racks
KRB13	PLZ20005WH2	For EIA inch racks
KRB600		For JIS millimeter racks

## Sequence Creation and Control Software NEW

### SD033-PLZ-5WH2 (Wavy for PLZ-5WH2)

Expand the ideas of engineers with the sequence creation and control software "Wavy"

The SD033-PLZ-5WH2(Wavy for PLZ-5WH2) is an application software designed for sequence creation and operation of Kikusui's PLZ-5WH2 series of DC electronic loads. It allows users to freely carry out sequence control of power supplies and electronic loads without any programming knowledge. Users can easily edit sequences as if drawing a picture or working on a spreadsheet.

- Able to easily create and edit sequence functions using a mouse.
- Execution positions are visually displayed during sequence execution.
- Monitors voltage and current, which can be saved into files.
- Monitor data displayed in real time as a monitor graph.

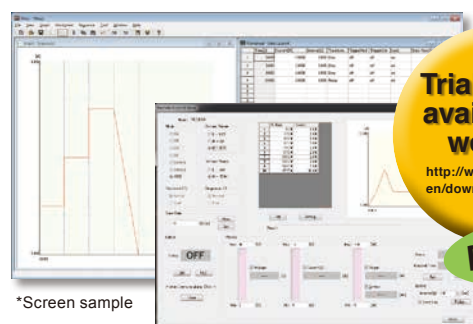

**Trial version available on website!**

<http://www.kikusui.co.jp/en/download/index.html>

**Download!**

## GPIB Converter (PIA5100)

This converter converts RS232C or USB of the PLZ-5WH2 to GPIB, enabling connection of a remote controller using GPIB.  
[Accessories: Power cord set, Magnetic sheet]



[Connection example]

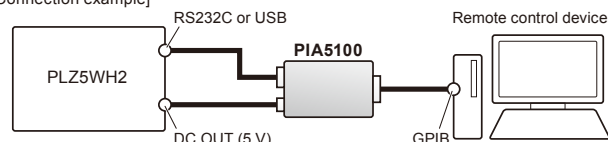

### KIKUSUI ELECTRONICS CORPORATION

Southwood 4F,6-1 Chigasaki-chuo,Tsuzuki-ku,Yokohama,224-0032,Japan  
Phone: (+81)45-482-6353,Facsimile: (+81)45-482-6261,www.kikusui.co.jp

KIKUSUI AMERICA, INC. 1-310-214-0000 [www.kikusuiamerica.com](http://www.kikusuiamerica.com)



3625 Del Amo Blvd, Suite 160, Torrance, CA 90503  
Phone: 310-214-0000 Facsimile: 310-214-0014

KIKUSUI TRADING (SHANGHAI) Co., Ltd. [www.kikusui.cn](http://www.kikusui.cn)



Room 305,Shenggao Building, No.137,Xianxia Road, Shanghai City, China  
Phone: 021-5887-9067 Facsimile: 021-5887-9069

For our local sales distributors and representatives, please refer to "sales network" of our website.

●Distributor:

■ All products contained in this catalogue are equipment and devices that are premised on use under the supervision of qualified personnel, and are not designed or produced for home-use or use by general consumers. ■ Specifications, design and so forth are subject to change without prior notice to improve the quality. ■ Product names and prices are subject to change and production may be discontinued when necessary. ■ Product names, company names and brand names contained in this catalogue represent the respective registered trade name or trade mark. ■ Colors, textures and so forth of photographs shown in this catalogue may differ from actual products due to a limited fidelity in printing. ■ Although every effort has been made to provide the information as accurate as possible for this catalogue, certain details have unavoidably been omitted due to limitations in space. ■ If you find any misprints or errors in this catalogue, it would be appreciated if you would inform us. ■ Please contact our distributors to confirm specifications, price, accessories or anything that may be unclear when placing an order or concluding a purchasing agreement.

Printed in Japan

Issue: Oct 2020 202010PDFEC11a