



Harmonic/Flicker Analyzer KHA Series

Supports harmonic and flicker compliance testing of single-phase and three-phase equipment

IEC61000-3-2 Ed4.0 (Harmonics for 16 A or less)

IEC61000-3-3 Ed3.0 (Flicker for 16 A or less)

IEC61000-3-11 Ed1.0 (Flicker for over 16 A)*

IEC61000-3-12 Ed2.0 (Harmonics for 75 A or less)*

IEC61000-4-7 Ed2.0/A1, Ed2.0, Ed1.0 (Interharmonics ON/OFF)

*Only Model KHA3000

Harmonic and flicker analyzer compliant with the latest versions of the IEC and JIS standards

Harmonic/Flicker Analyzer

KHA Series

Type for the "Three-phase / Single-phase with large current"

KHA3000

Type for the "Single-phase"

KHA1000

- ◆ Supports new and old harmonics/flicker standards of IEC/EN and JIS.
- ◆ Using this device alone, measurement, analysis and report creation are possible.
- ◆ Basic measurements required at design and development sites are possible.
- ◆ Pass/fail judgment on limit value is possible.
- ◆ Real-time display of test status.
- ◆ Easy support with update kit when standards are updated.(for a fee)

The KHA series is a Harmonic/Flicker analyzer that complies to the standard of IEC/EN and JIS. The KHA1000 is dedicated for the single-phase equipment with two wires, and the KHA3000 applies to the test exceeding 16 A of the single-phase and three-phase equipment (up to 40 A per phase). Furthermore, the KHA series is compliant with both existing and the latest version of measurement technique standards, so you can simply select the measurements of the latest version of standard including the interharmonics, and for the conventional measurement that applies only the integral multiple harmonics without using any other device. In addition to the real-time display that can be used like an oscilloscope and FFT analyzer, the KHA series offers the real-time judgment of compliance with standards. Using the KHA series alone, you can judge test results and prepare result reports without using a PC. On top of that, you can easily configure the test system combined with the AC power supply (PCR-LE/LE2 Series) and the line impedance network (LIN Series).

*Measurement beyond 40 A/phase can be supported by firmware ver.2.00 or later of KHA3000, and clamp-on probe on shelves.

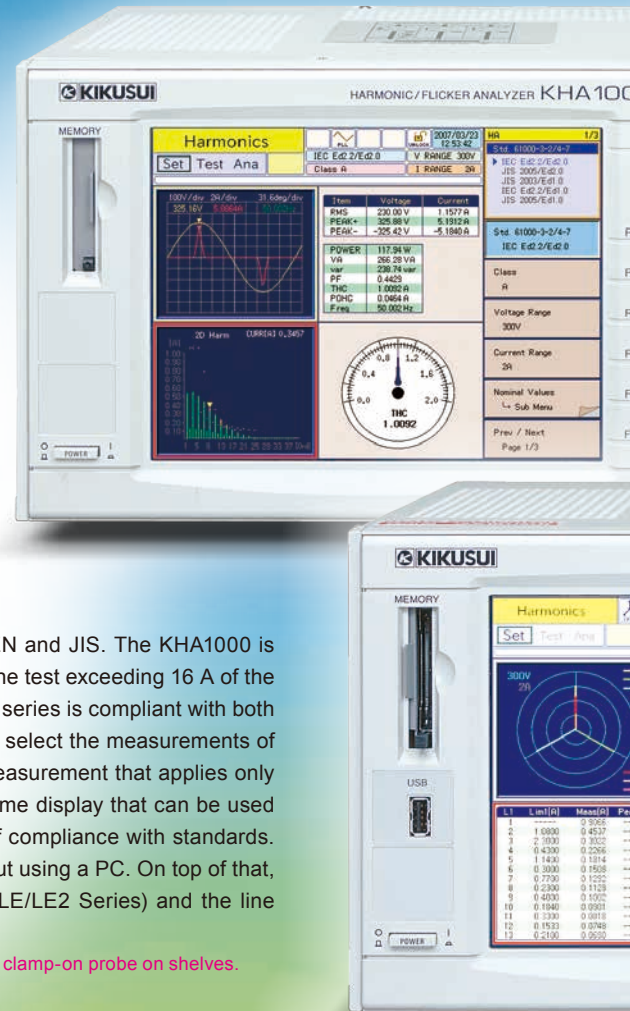

[Complied standards] Compliance with the following standards can be tested.

Category	Limit value standard Edition	Measurement technique standard Edition
Harmonic current	IEC 61000-3-2 Ed3.0(2005) IEC 61000-3-2 Ed4.0(2014) IEC 61000-3-2 Ed2.2(2004) EN 61000-3-2(2000)/A2(2005) EN 61000-3-2(2014) EN 61000-3-2(2006)	16 A or less
	JIS C61000-3-2(2005) JIS C61000-3-2(2011)	20 A or less
	IEC 61000-3-12 Ed1.0(2004) IEC 61000-3-12 Ed2.0(2011)	16 A or more, 75 A or less
Flicker/ voltage fluctuation	IEC 61000-3-3 Ed2.0(2008) IEC 61000-3-3 Ed3.0(2013) EN 61000-3-3(2013) EN 61000-3-3(2008)	16 A or less
	IEC 61000-3-11 Ed1.0(2000)	16 A or more, 75 A or less
		IEC 61000-4-7 Ed2.1(2009), EN 61000-4-7(2002)/A1(2009) *1 IEC 61000-4-7 Ed2.0(2002), EN 61000-4-7(2002) *1 IEC 61000-4-7Ed1.0(1991), EN 61000-4-7(1993) *2
		IEC 61000-4-15 Ed2.0(2010), EN 61000-4-15(2011) IEC 61000-4-15 Ed1.1(2003), EN 61000-4-15(1998)/A1(2003)

1. The measuring window width is 0.2 second. In other words, it is 10 cycles at a fundamental frequency of 50 Hz and 12 cycles at a fundamental frequency of 60 Hz. Interharmonic waves are measured at 5 Hz intervals. Harmonic groups are measured out of harmonic waves and interharmonic waves. The values of harmonic groups are the results of measurement.
2. The measurement window length is 16 cycles at the fundamental frequency. It is 0.32 second at a fundamental frequency of 50 Hz and 0.266 second at a fundamental frequency of 60 Hz. Interharmonic waves are not measured; only harmonic waves are measured. The values of harmonic waves are the results of measurement.

◆ Applying to the single phase and the three-phases* (40 A/phase)

*Only Model KHA3000

	16 A/phase or less *1	16 A to 75 A/phase *2
	IEC61000-3-2, -3-3	IEC61000-3-12, -3-11
Single phase	KHA1000 dedicated for single phase (16 A or less).	
Three phase		KHA3000 Covers all.

*1: The JIS specifies 20 A/ phase or less.

*2: For measurement of 40 A or more phase current, an optional device (external current sensor) is required.

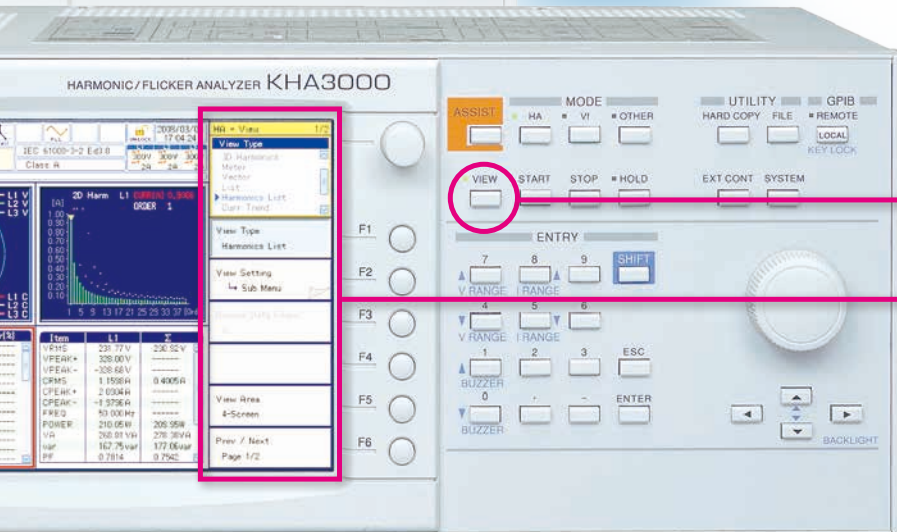

VIEW key

You can change the test conditions with the monitor screen unchanged.

◆ User-friendly terminals and interfaces

KHA Series comes standard with GPIB, RS232C and USB.

SCPI commands make it possible to use the unit as a general-purpose power analyzer by connecting it to your computer.

▼KHA3000 Rear panel

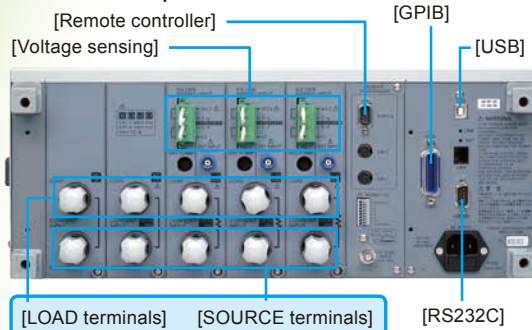

▼KHA1000 Rear panel

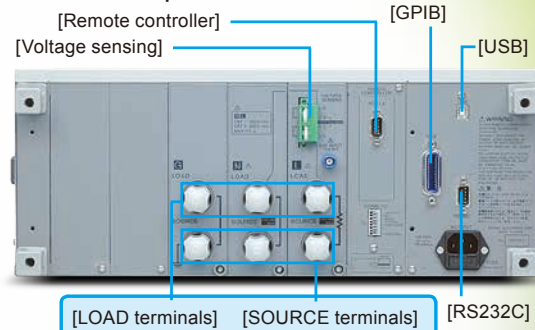

Easy connection

The terminals for power input and load output are separated. This arrangement prevents connection errors, thereby eliminating the risk of short-circuiting. Of course, voltage sensing at the load is supported as well. KHA3000 offers both simplicity and expandability.

Features

Complied with the old and new versions of harmonic measuring instrument standards IEC61000-4-7

To select the standard, your desired combination can be arranged by choosing from the limit value standard and the testing measurement standard. *It is only a combination made beforehand in KHA1000.

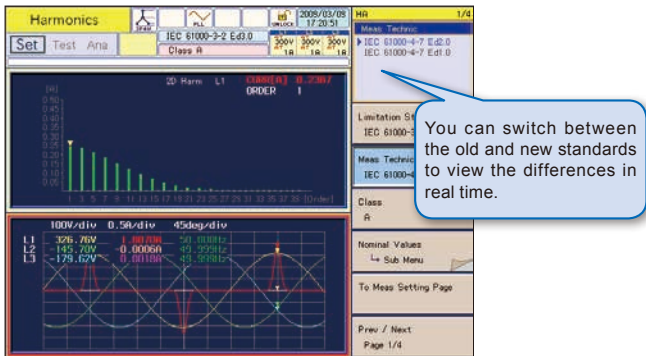

Harmonic measuring instrument standard	IEC61000-4-7 Ed2.1	IEC61000-4-7 Ed2.0	IEC61000-4-7 Ed1.0
Window width	200 ms 10 cycle/50 Hz 12 cycle/60 Hz	200 ms 10 cycle/50 Hz 12 cycle/60 Hz	16 cycle
Interharmonics	Interharmonics grouping (unit of 5 Hz)*3	Interharmonics grouping (unit of 5 Hz)	None Integer order harmonics only

*3: It isn't grouping below the second harmonics.

Supporting "repeatability" check

Comparison can be made between the present measurement data and the past measurement data to check whether or not the error is within the specified allowable range. This feature is helpful in evaluating the "repeatability" that is required in harmonic compliance testing.

The IEC requirements

The measurement repeatability shall be within ±5% of limit value.

IEC61000-3-12: The repeatability of the fundamental and 7th and lower harmonic orders shall be within ±5%.

The repeatability of the harmonics beyond the 7th harmonic order shall be within ±10% or ±1% of the reference fundamental current, whichever is larger.

Conducting compliance testing without using a PC

Using this device alone, you can perform a series of test processes - from setting test conditions and running the test to judging test results against limit values and outputting result reports - without the use of a PC. The device displays pass/fail results and spectrum data on the screen in real time. What's more, since KIKUSUI's PCR-LE/LE2 Series AC power supply can be controlled from KHA Series, you can set up an easy-to-use test system whereby the operation panel of this device can be used as the main console.

● Operation flow using KHA Series - from test condition setting to report printing

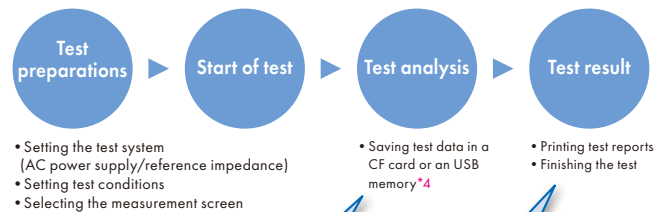

- Setting the test system (AC power supply/reference impedance)
- Setting test conditions
- Selecting the measurement screen
- Saving test data in a CF card or an USB memory*4
- Printing test reports
- Finishing the test

Link to a PC with using a CF card or an USB memory*4 (external memory). A Compact Flash (CF) memory card is used to save test conditions, reports, screen hardcopies and data.

Test reports can be output to a CF card in either the PDF or text format. You can easily view and print them using a PC. The text format is useful when you want to prepare a report in your own format.

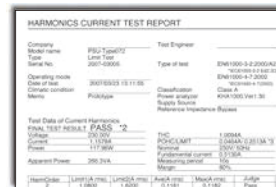

▲ Example of test report (harmonic compliance test)

*4: Support for USB memory is Only Model KHA3000.

Equipped with a quality check function for the testing power supply

KHA Series are equipped with a function to measure the voltage, frequency, peak voltage and distortion rate of the AC power used for harmonic compliance testing in order to check whether or not the power supply is adequate for the intended test.

The IEC requirements

IEC61000-3-2:

The voltage harmonics must be the following values or less.
3rd (0.9%), 5th (0.4%), 7th (0.3%), 9th (0.2%), even harmonic order between 2nd and 10th (0.2%), 11th to 40th (0.1%)

IEC61000-3-12:

Output voltage and harmonic inclusion rate under no load
5th (1.5%), 3rd and 7th (1.25%), 11th (0.7%), 9th and 13th (0.6%), even harmonic orders between 2nd and 10th (0.4%), 12th and 14th to 40th (0.3%)

Capable of simultaneous measurement of the three-phases *Only Model KHA3000

The long-time flicker value in all segment time, "Plt" is specified to be 2 hours for the flicker monitoring period.
 For three-phase equipment, measurement can be taken for each phase, but that will take 2 hours x 3 = 6 hours.
 Simultaneous measurement of three-phases can shorten the measuring (testing) time to 2 hours.

- In order to fully cover the EUT input methods, you can set the wiring method (single phase, single phase 3-wire, three-phase 3-wire and three-phase 4-wire). In addition, for the setting of L1, L2 and L3 (channels), you can select interlock or independent. This allows appropriate measurement for equipment with largely different phase currents.
- In order to support measurement of each channel for 3 phases, the voltage and current ranges were separated for each channel and AUTO range was established for each. In addition, you can adjust the DC offset for each range with a single touch.

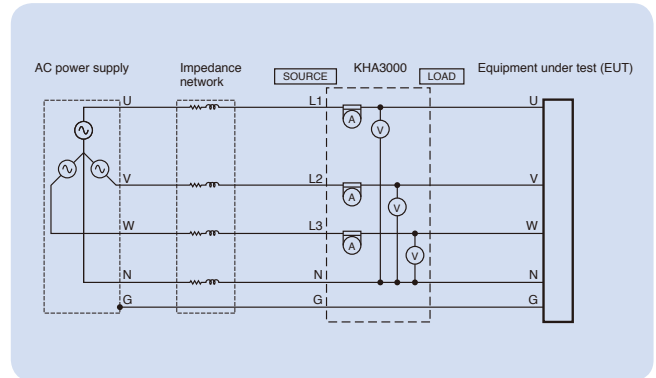

Easy upgrade when standards are updated (supports the latest standards)

The unit can be easily upgraded from the front panel using a CF card.*5

*5: Users are requested to prepare CF cards.



Providing all major basic measurements

KHA Series are capable of measuring all major basic items including voltage, current, power, power factor, apparent power, reactive power and frequency.
 It also provides other measurement functions such as waveform monitoring and measurements of rush current and harmonic current in low frequency zones.
 These features make KHA Series a convenient routine work tool for development and design processes.

Real-time display & measurement that gives you a quick grasp of the EUT status

List of view types *The screens are examples of KHA3000.

	Harmonic current test	Flicker/voltage fluctuation test
Graph display	<ul style="list-style-type: none"> V/I waveforms 2D harmonics 3D harmonics THC Current trend Harmonic current trend Vector phases *Only Model KHA3000 	<ul style="list-style-type: none"> V/I waveforms rms waveform St (short time flicker value) waveform CPF (cumulative probability) curve dc waveform dmax waveform d (t) > 3.3% waveform
List display	<ul style="list-style-type: none"> List (real-time measured values) Harmonic list Result list 	<ul style="list-style-type: none"> Flicker list Result list d measurement (manual switch)



▲ 2D harmonics



▲ Flicker list

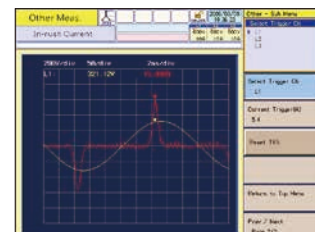

▲ Rush current measurement (KHA3000)

Rush current measurement

KHA Series observes the waveform of the rush current exceeding the trigger level. It can also observe the voltage waveform. KHA3000 can measure a rush current up to 160 Apeak, KHA1000 can measure a rush current up to 80 Apeak.
 The measuring range can be expanded to a high current by using an optional external current sensor with updating the firmware.

A rush current can be measured while the EUT is connected. This saves you from going through the trouble of preparing an oscilloscope and current probe. Set the input phase angle of the AC power supply using the application software (SD006-KHA, SD005-KHA), and turn on the unit. The rush current can be measured with good reproducibility. The phase angle can be set in the unit of 1°.

Performance

◆ KHA1000 System Components [For Single-phase/4 kVA, PC Control]

For PCR-LE

●Single-phase 2-wire circuit test

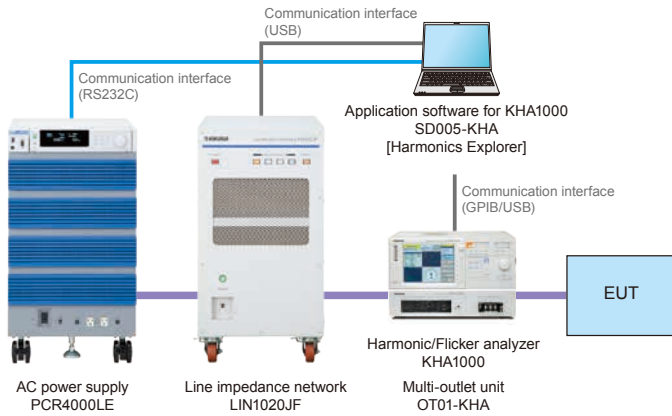

Single-phase 2-wire system (4 kVA) configuration example

capacity	model	quantity
4 kVA	PCR4000LE	1
	LIN1020JF	1
	KHA1000	1
	OT01-KHA	1
	SD005-KHA	1

◆ KHA3000 System Components [For Single-phase/8 kVA, 3-phase/12 kVA, PC Control]

For PCR-LE

●Three-phase 3-wire circuit / three-phase 4-wire circuit test

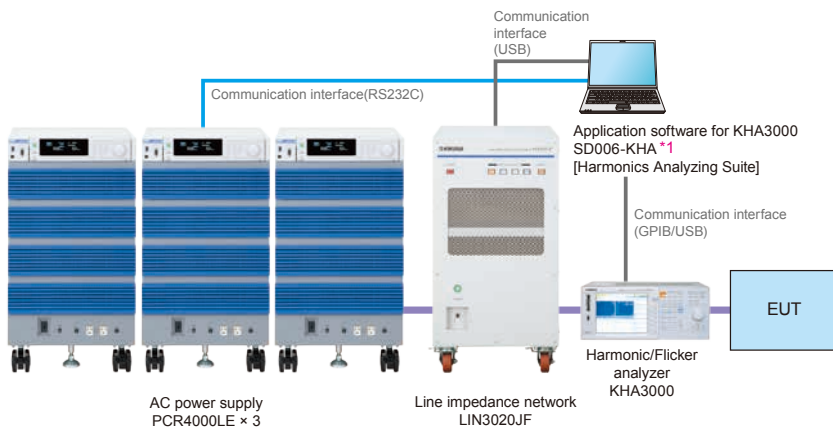

Three-phase operation system (12 kVA) configuration example

capacity	model	quantity
12 kVA	PCR4000LE	3
	LIN3020JF	1
	3P05-PCR-LE	1
	KHA3000	1
	SD006-KHA	1

*1 SD006-KHA Ver2.41 or later is required

◆ KHA3000 System Components [For Single-phase 3three-phase/6 kVA, Single-phase 3-wire/4 kVA, PC Control]

For PCR-LE2

●Single-phase 2-wire circuit test / Single-phase 3-wire circuit / Three-phase 3-wire circuit / Three-phase 4-wire circuit test

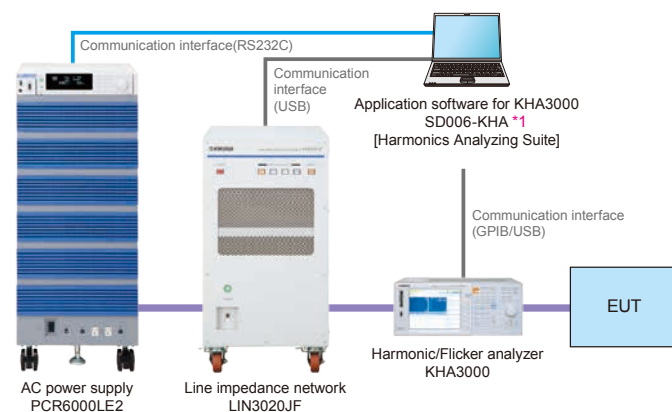

Single-phase 2-wire (6 kVA)/single-phase 3-wire (4 kVA)/
three-phase system (6 kVA) configuration example

capacity	model	quantity
6 kVA *Single-phase 3-wire /4 kVA	PCR6000LE2	1
	LIN3020JF	1
	KHA3000	1
	SD006-KHA	1

*1 SD006-KHA Ver2.41 or later is required

◆ The large current CT (Current Transformer) for the KHA3000

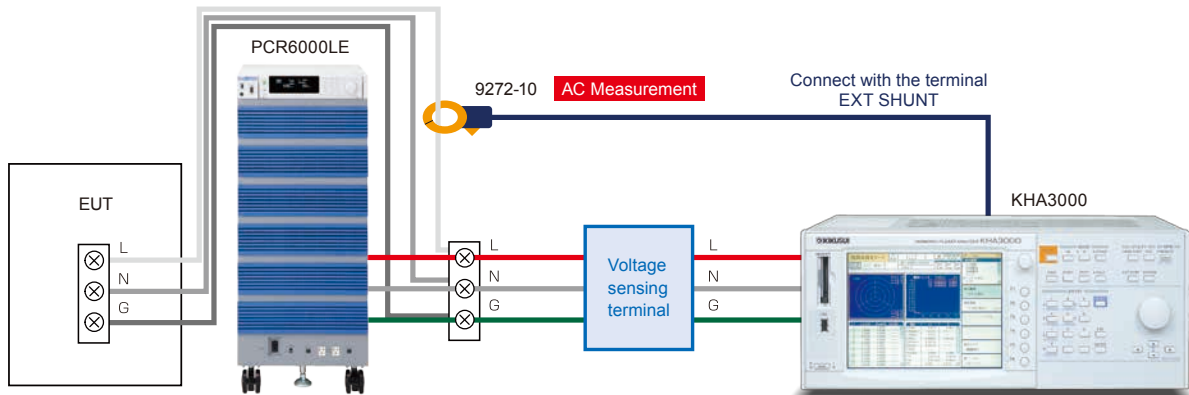

Comparison of the measurement value

The Internal Shunt VS
9018-50/9272-10
by HIOKI

- HIOKI 9018-50 50A Mode (12.5 A range)
- ▲ HIOKI 9018-50 100A Mode (12.5 A range)
- × HIOKI 9272-10 200A Mode (10 A range)

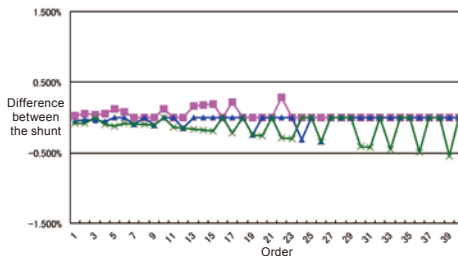

*The relative error between the measurement value by the internal shunt resistor and the measurement value of the harmonics current by the clamp sensor (manufactured by HIOKI) is measured within $\pm 0.6\%$, therefore, the sufficient precision is confirmed in the practical operation applied to the standard requirement of 5% specified in the IEC61000-4-7.

Information of the clamp current sensor



CLAMP ON SENSOR
9272-10

CLAMP ON PROBE
9018-50

SENSOR UNIT
9555-10

For inquiry: HIOKI E. E. CORPORATION <http://www.hioki.co.jp/>

◆ Application example of the combination system with other manufacture's equipment

Use the terminal "I Monitor" and "V Monitor" on the back of RIN.

*In order to satisfy the voltage drop of 0.5 Vrms in the measurement specified in the IEC61000-4-7 Ed2, it is recommended that the wiring between the OUTPUT and the SOURCE terminal of the KHA series must be connected short and use the thick cable as possible (at least thicker than 8mm², 16mm² to 22mm² for measuring more than 16 A).

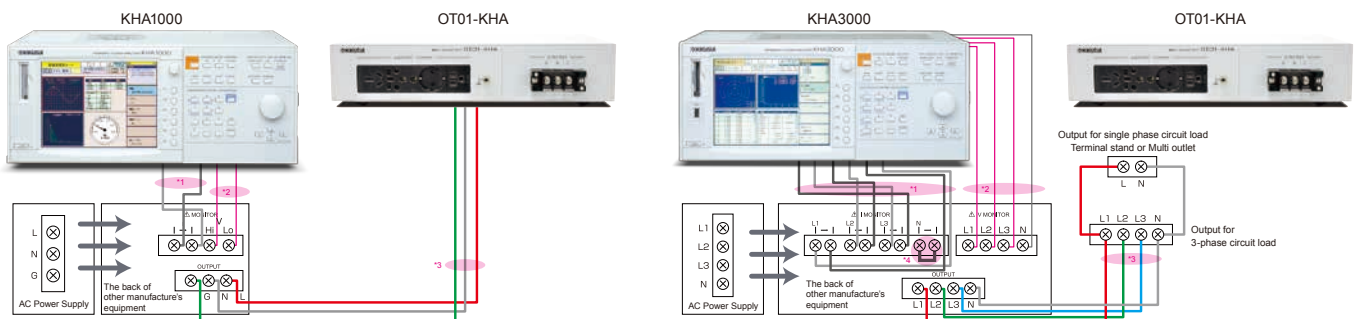

- *1: Current sensing wire: Use the wire with sufficient capacity which allows up to 20 A for the KHA1000, and up to 40 A for the KHA3000.
- *2: Voltage sensing wire: There is no current flows on this wire, so the wire size should be sufficient with the type around "UL1015 AWG20". (It should be concerned for the withstanding voltage)
- *3: Output wire: Select the wire with the current capacity of 20 A for the KHA1000, and 40 A for the KHA3000. It may cause to effect for the voltage drop. (Recommended of the wire size : 14mm² to 22mm²)
- *4: The short-bar must be connected.
- *5: Set it to KHA3000 Ver2.00 or more and Delta Transform "Enable".

Options

- ◆ KHA3000 Application software [SD006-KHA] Harmonics Analyzing Suite
- ◆ KHA1000 Application software [SD005-KHA] Harmonics Explorer

Compliant IEC, JIS latest standards

This dedicated application software consists of 3 programs. Using this software, you can set test conditions and control the execution of tests. You can also control the AC power supply (PCR-LE) used for tests. Furthermore, you can print the harmonic spectrum, and current and voltage waveforms on your reports.

■ Program configuration of SD006-KHA Harmonics Analyzing Suite and SD005-KHA Harmonics Explorer

SD006-KHA	SD005-KHA	Specifications
HarmoCapture 3	HarmoCapture	Offers functions to set conditions for harmonic current tests and voltage fluctuation tests, read test conditions, execute tests and save and display test result data. ●Test condition setting ●Start/stop of test ●Retrieval of test result files ●Display of measured values ●Control of AC source PCR-LA ●Entry of comments ●Report printing
HA File Analyzer 3	HA File Analyzer	Offers functions to analyze harmonic test data. ●Display of test result list ●Display of graphs (V/I waveforms, 2D harmonics, 3D harmonics, vectors, current trend, harmonic trend and THC trend) ●Saving of test result files in text format and repeatability check ●Report printing
Vf File Analyzer 3	Vf File Analyzer	Offers functions to analyze voltage fluctuation test data. ●Display of test result list and display of flicker list ●Display of graphs (dc%, dmax%, d(t) >3.3%) (CPF) ●Saving of test result files in text format ●Report printing

[System requirements]

- Personal computer with Microsoft Windows 10 or 7 (32-bit or 64-bit) ●At least 2 GB of memory (4 GB or more recommended) ●1024 x 768 dots or higher resolution ●20 GB or more free hard disk space (more space required for saving data) ●CD-ROM drive ●Mouse or other pointing device ●VISA libraryNI-VISA 4.1 or later; Keysight IO Libraries Suite 14.1 or later; or KI-VISA 4.2.2 or later ●USB cable (when using USB) ●GPIB card and IEEE488 cable (when using GPIB) ●Cross serial cable (when controlling AC power supply via RS232C)
- CompactFlash Type I (CFA), up to 512 MB (when using KHA3000 files)

HarmoCapture 3 / HarmoCapture

HarmoCapture 3 / HarmoCapture lets you control KHA Series remotely from a PC in the same way you control it from the operation panel of the device. The program will start as appropriate for the test mode.

▼ Test condition setting screen for harmonic current test (HarmoCapture 3)

▼ Test condition setting screen for harmonic current test (HarmoCapture)

The image shows two screenshots of software interfaces for setting test conditions. The left screenshot is for HarmoCapture 3 and the right is for HarmoCapture. Both screens have various panels and controls highlighted with pink callouts:

- Test mode selection pane:** Located at the top left of both screens, containing icons for 'HA' and 'VF'.
- Test standard selection pane:** Located at the top center of both screens, showing a list of standards.
- Indicator pane:** Located at the top right of both screens, showing status indicators.
- Measured valuemonitor pane:** Located on the right side of both screens, displaying real-time measurement data.
- Voltage and current range selection pane:** Located at the bottom left of the HarmoCapture 3 screen.
- AC power source control pane:** Located at the bottom left of the HarmoCapture screen.
- Standard conditions setting pane:** Located at the bottom right of both screens, containing various configuration options.

HA File Analyzer 3 / HA File Analyzer

HA File Analyzer 3 / HA File Analyzer are application programs that allows you to analyze the data in the test result files (xxx.hr3 / xxx.hr) saved by HarmoCapture 3 / HarmoCapture. It is not necessary to connect with KHA Series to run, so, you can analyze test data anywhere you want.

▼HA File Analyzer 3/Screen configuration

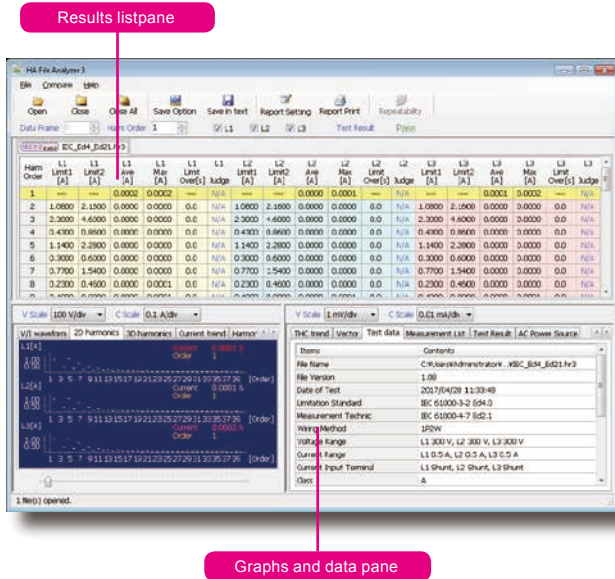

▼HA File Analyzer/Screen configuration

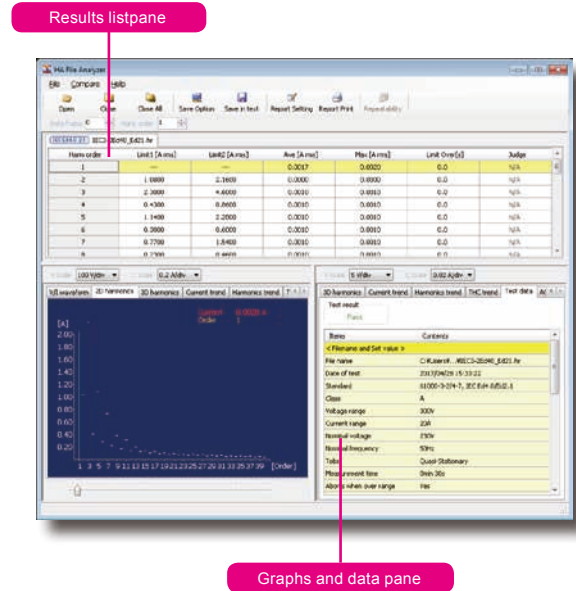

Vf File Analyzer 3 / Vf File Analyzer

VF File Analyzer 3 / VF File Analyzer are application programs that allows you to analyze the data in the test result files (xxx.vr3 / xxx.vr) saved by HarmoCapture 3 / HarmoCapture. It is not necessary to connect with KHA Series to run, so, you can analyze test data anywhere you want.

▼VF File Analyzer 3/Screen configuration

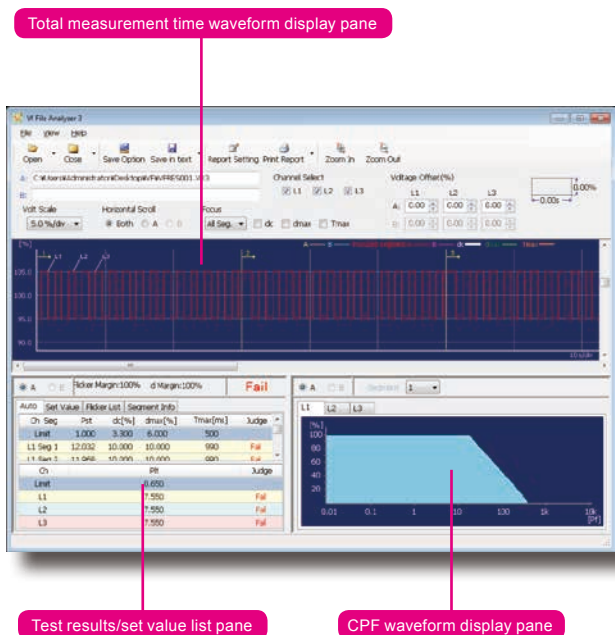

▼VF File Analyzer/Screen configuration

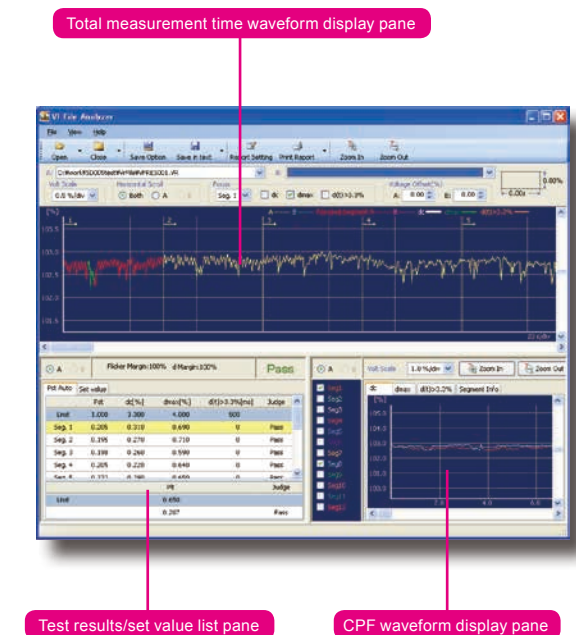

Options

Line Impedance Network

LIN series (LIN1020JF/LIN3020JF/OP01-LIN1020JF)

It is equipped with the IEC/JIS/JET standard impedance.
It supports voltage fluctuation and flicker tests.



▲LIN3020JF

■ LIN1020JF (For single phase 20 A) *1

LIN1020JF is equipped with the impedance determined by the IEC flicker test (IEC61000-3-3) and JIS harmonics (JIS C61000-3-2), which can be configured via the USB interface (standard feature) or the contact signal interface from the application software. The single-phase two-wire IEC flicker/harmonics test system can be configured in combination with AC power supply PCR-LE/LE2 and harmonic flicker analyzer KHA1000/KHA3000.

■ LIN3020JF (For single phase / three phase 20 A) *1

LIN3020JF is equipped with the impedance determined by the IEC flicker test (IEC61000-3-3) and JIS harmonics (JIS C61000-3-2), which can be configured via the USB interface (standard feature) or the contact signal interface from the application software. The single-phase two-wire/three-wire/three-phase IEC flicker/harmonics test systems can be configured in combination with AC power supply PCR-LE/LE2 and harmonics flicker analyzer KHA1000/KHA3000.

*1: The LIN-JF can be used with PCR-LE and PCR-LE2 AC power supplies.

PCR-L and PCR-LA series or AC power supplies made by other manufacturers cannot be used.

■ OP01-LIN1020JF

OP01-LIN1020JF is an additional unit that is used to expand LIN1020JF in three phases (addition of V phase and W phase).

* OP01-LIN1020JF does not work solely.

Model	Maximum current (per phase)	Wiring configuration	Complied standard			Remarks
			IEC 61000-3-3 230 V 50 Hz	JIS C61000-3-2 *2 JET GR0002-1-3.0		
				100 V 50/60 Hz	200 V 50/60 Hz	
LIN1020JF	20 A	Single phase 2-wire	✓	✓	✓	Product for IEC flicker / voltage fluctuation test *2: Insertion of the impedance is optional in the JIS harmonics test. (Normally applied for bypass.) *3: OP01-LIN1020JF does not work solely.
LIN3020JF		Single phase 2-wire/3-wire Three phase 3-wire/4-wire	✓	✓	✓	
LIN1020JF + OP01-LIN1020JF *3		Single phase 2-wire/3-wire Three phase 3-wire/4-wire	✓	✓	✓	
Impedance Value	Single phase 2-wire		0.4 Ω +Jn0.25 Ω(Z3)	0.4 Ω +0.37 mH(Z1)	0.38 Ω +0.46 mH(Z2)	
	Single phase 3-wire Three phase 3-wire Three phase 4-wire		0.24 Ω +Jn0.15 Ω (0.16 Ω +Jn0.1 Ω for N phase)	0.19 Ω +0.23 mH (0.21 Ω +0.14 mH for N phase)	0.19 Ω +0.23 mH (0.19 Ω +0.23 mH for N phase)	

◆ Accessories and others

■ Multi-outlet (20 A or less single phase)

OT01-KHA

This unit allows you to connect various types of plugs used around the world.



■ Rack mount brackets

[For KHA3000/1000]

KRB4 (inch)

KRB200 (millimeter)

[For OT01-KHA]

KRB2-TOS (inch)

KRB100-TOS (millimeter)

■ Ethernet port [Factory-set option]

*Specify when ordering. *Only Model KHA1000

You can print on the network printer directly from the ethernet port. Easy to build a harmonic test system without the use of a PC.

■ Daily pre-test checker

OP02-KHAS(SPEC40425)

Item	Description
Operation mode	Harmonic mode / Flicker mode
Control type	Resistive load method (forced air cooling)
Input voltage range	Single-phase 100 VAC to 240 VAC
Input voltage type	Single-phase two-wires Single-phase three-wires (change by per phase) Three-phase four-wires (change by per phase)
Input current	2.3 A \pm 5 % (when at the setting voltage of 230 V) 1.0 A \pm 5 % (when at the setting voltage of 100 V) *Maximum power when through the phase control
Allowable current for the external load connecting terminal	Approx. maximum 10 A
Harmonic generation method	Phase control
Phase angle variation range	Approx. 10 to 170 (when at the setting voltage of 100 V or 230 V)
Thermal protection	Yes (ALARM lights on, a buzzer sounds)
Flicker generation method	Square-wave ON/OFF control by the electronic timer
Flicker frequency setting range	Approx. 0.5 Hz to 20 Hz
Warm-up time	Approx. 10 minutes
Power supply for the activation	Single-phase 86 VAC to 264 VAC, less than 75 W (possible for common use of the measurement circuit)
Withstanding voltage	Between the Input and FG(Frame Ground) 1830 V, less than 5 mA
Dimensions	214(W) \times 124(H) \times 400(D)mm (Excluding the projected components)
Weight	Approx. 6 kg



The OP02-KHAS(SPEC40425) is the resistive load device that confirms the operation of the "harmonic current/flicker measurement system" performs properly. The OP02-KHAS(SPEC40425) is able to perform the daily check of the harmonic measurement standard "EN/IEC61000-3-2", "EN/IEC61000-3-12", and the flicker measurement standard "EN/IEC61000-3-3", "EN/IEC61000-3-11" for the "harmonic current/flicker measurement system"

◆ Calibration of ISO/IEC17025: Provided with calibration/data (measuring equipment in use)

In order to meet the customers' request for traceability of the calibration of KHA Series for ISO/IEC17025, we have established the "traceability system" as shown in the figure below. (It is used for the production and inspection of KHA1000/3000.)

When the "Certificate of traceability with Calibrator Data" is requested, a copy of the "Calibration Certificate" can be also attached as a chargeable option. (issued by the organizations shown in).

Calibration of KHA Series is carried out using the measuring instruments calibrated in compliance with ISO/IEC17025.

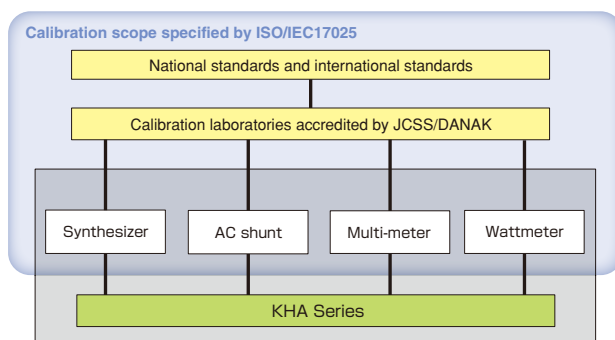

▲Outline diagram of traceability

Note that KIKUSUI cannot calibrate KHA1000/3000 in compliance with ISO/IEC17025.

Thus, the calibration data for KHA Series that can be provided at the moment does not contain of "the Expression of Uncertainty". A copy of the data that contains of "the Expression of Uncertainty" for the measuring instruments used for calibration can be attached as a chargeable option.

If you need data issued by accredited calibration laboratories (with the logos), please contact our sales representatives.

Specifications		KHA3000	KHA1000	
Common input specifications	Maximum input voltage	600 Vrms / 900 Vpeak (CAT I), 400 Vrms (CAT II)	300 Vrms / 560 Vpeak (CAT I), 250 Vrms (CAT II)	
	Maximum input current	40 Arms / 100 Apeak, whichever is smaller 160 Apeak (within 20 ms)	24 Arms / 50 Apeak, 80 Apeak (within 20 ms)	
	Number of input channels	3 channels for both voltage input and current input (L1, L2 and L3)	1 channels for both voltage input and current input	
	Voltage measurement input switching	Single-phase 2-wire, single-phase 3-wire, three-phase 3-wire and three-phase 4-wire	Single-phase 2-wire	
Voltage measurement function	Rated voltage for the range	150 V/300 V/600 V	150 V/300 V	
	Allowable crest factor	2		
	Display item	TrueRMS and \pm peak		
	Accuracy	\pm (0.4 % of rdng + 0.04 % of range)		
Current measurement function	Rated current for the range	0.5 A/1 A/2 A/5 A/10 A/20 A/ 40 A	0.5 A/1 A/2 A/5 A/10 A/20 A	
	Allowable crest factor	0.5 A to 20 A range: 4, 40 A range: 2.5 and 4 (up to 20 ms)	0.5A to 10 A range: 4, 20 A range: 2.5	
	Accuracy *1	45 Hz to 65 Hz	0.5 A range: \pm (0.5 % of reading + 0.2 % of range) 1 A to 40 A range: \pm (0.5 % of reading + 0.1 % of range)	0.5 A range: \pm (0.5 % of reading + 0.2 % of range) 1 A to 20 A range: \pm (0.5 % of reading + 0.1 % of range)
		66 Hz to 2.4 kHz	0.5 A range: \pm ((0.5 + 0.417 \times n kHz) % of reading + 0.2 % of range) 1 A to 40 A range: \pm ((0.5 + 0.417 \times n kHz) % of reading + 0.1 % of range)	0.5 A range: \pm ((0.5 + 0.417 \times n kHz) % of reading + 0.2 % of range) 1 A to 20 A range: \pm ((0.5 + 0.417 \times n kHz) % of reading + 0.1 % of range)
Power measurement function	Display item	Effective power, apparent power, reactive power and power factor		
	Effective power accuracy	P \geq 150 W (\pm 1 % of range), P < 150 W (\pm 1.5 W)		
Frequency measurement function	Measurement input	Independent measurement of frequencies for voltages of L1, L2 and L3		
	Measurement frequency range/accuracy/resolution	45 Hz to 65 Hz / \pm (0.15 % of reading + 2 digits) / 0.001 Hz		
Phase measurement function	Measurement item	Voltage/current phases, line voltage phase *2 and harmonic phase		
	Measuring range/resolution	0.00° to 359.99° / 0.01°		
Harmonic current measurement function	Conforming standard	IEC 61000-3-2 Ed4.0, IEC 61000-3-2 Ed3.0, IEC 61000-3-2Ed2.2, IEC 61000-3-2 Ed4.0 (2014), IEC 61000-3-2 Ed2.2 (2004), IEC 61000-3-2 Ed3.0 (2005), JIS C61000-3-2(2005), IEC 61000-3-12 Ed1.0		
	Requirements for measuring instrument standard	IEC 61000-4-7 Ed2.1(2009), IEC 61000-4-7 Ed2.0(2002), IEC 61000-4-7 Ed1.0(1991)		
	Harmonic analysis order	40 th (HA mode), 180 th (OTHER mode)		
	Interharmonics processing	Processing ON (2nd order and more): IEC 61000-4-7 Ed2.1(2009), Processing ON: IEC 61000-4-7 Ed2.0(2002) Processing OFF: IEC 61000-4-7 Ed1.0(1991)		
	Window function	Rectangular		
	Window width	10 cycles(50 Hz) 12 cycles(60 Hz), 16 cycles(50 Hz/60 Hz)		
	Anti-aliasing filter	Cutoff frequency: 6 kHz, 4 th Butterworth type (HA mode), 15 kHz 4 th Butterworth type (Other mode)		
	Class D judgment function	—		
Harmonic voltage measurement function	Measurement item	Voltage, frequency and voltage harmonic inclusion rate		
	Voltage harmonic analysis order	40 th		
Flicker/voltage fluctuation analysis function	Conforming standard	IEC 61000-3-3 Ed3.0(2013), IEC 61000-3-3 Ed2.0(2008), IEC 61000-3-11 Ed1.0(2000) *2		
	Requirements for measuring instrument standard	IEC 61000-4-15 Ed2.0(2010), IEC 61000-4-15 Ed1.1(2003)		
	Flicker	Pst accuracy	1 \pm 5 %	
		Pst measurement time	30 to 900 seconds	
	Voltage fluctuation	Measurement method	Selectable between simultaneous measurement with Pst and independent measurement	
General measurement function	dmax measurement of manual switching equipment	3 to 24 times (Measuring time for each time: 30 to 180 seconds)		
	Current/voltage waveform monitor, FFT analyzer and In-rush current measurement			
Communication interface	GPIB, RS232C, USB			
Removal data storage	Supported media	Compact Flash memory card (CF card) *4, maximum capacity: 512 MB, USB Memory*2, maximum capacity: 16 GB		
External equipment control function	PCR-LE control (RS232C)	Voltage, frequency, range, ON phase, OUTPUT ON and OFF		
AC Input	Nominal voltage range	100 V to 240 V AC 50 Hz to 60 Hz		
Environmental conditions	Operating temperature and humidity ranges	0 °C to +40 °C (+32 °F to +104 °F), 20 %rh to 80 %rh (no condensation)		
Withstanding voltage	1500 VAC, 1 minute (AC input \leftrightarrow chassis), 3550 VAC, 1 minute (measuring terminal \leftrightarrow chassis)	1500 VAC, 1 minute		
Dimensions (maximum)	430(16.93)/455(17.91)W \times 177(6.97)/(195(7.68))H \times 270(10.63)/330(12.99)D mm(inch)			
Weight	Approx. 10 kg (22.05 lb)		Approx. 8 kg	
Safety	Conforming to the following standard requirements: IEC 61010-1:2001 (Class I, Pollution degree 2)			
Accessories	Power cord, voltage sensing terminal plug and short-circuit wire kit (with a dedicated screwdriver), spare fuse and operation manual			

*1: n = indicates frequency. *2: Only Model KHA3000. *3: Only Model KHA1000 *4: Users are requested to prepare the CF card. Note that the maximum supported capacity of a CF card is 512 MB.

—Outside Dimensions—

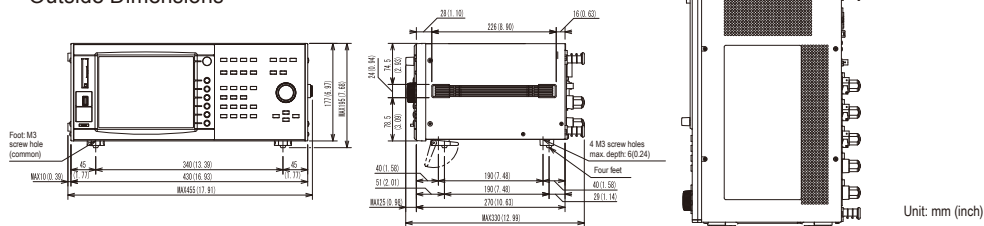

Unit: mm (inch)



KIKUSUI ELECTRONICS CORPORATION

Southwood 4F,6-1 Chigasaki-chuo,Tsuzuki-ku,Yokohama,224-0032,Japan
Phone: (+81)45-482-6353,Facsimile: (+81)45-482-6261,www.kikusui.co.jp

KIKUSUI AMERICA, INC. 1-310-214-0000 www.kikusuiamerica.com



3625 Del Amo Blvd, Suite 160, Torrance, CA 90503
Phone : 310-214-0000 Facsimile : 310-214-0014

KIKUSUI TRADING (SHANGHAI) Co., Ltd. www.kikusui.cn



Room 305,Shenggao Building , No.137,Xianxia Road, Shanghai City, China
Phone : 021-5887-9067 Facsimile : 021-5887-9069

For our local sales distributors and representatives, please refer to "sales network" of our website.

●Distributor:

■ All products contained in this catalogue are equipment and devices that are premised on use under the supervision of qualified personnel, and are not designed or produced for home-use or use by general consumers. ■ Specifications, design and so forth are subject to change without prior notice to improve the quality. ■ Product names and prices are subject to change and production may be discontinued when necessary. ■ Product names, company names and brand names contained in this catalogue represent the respective registered trade name or trade mark. ■ Colors, textures and so forth of photographs shown in this catalogue may differ from actual products due to a limited fidelity in printing. ■ Although every effort has been made to provide the information as accurate as possible for this catalogue, certain details have unavoidably been omitted due to limitations in space. ■ If you find any misprints or errors in this catalogue, it would be appreciated if you would inform us. ■ Please contact our distributors to confirm specifications, price, accessories or anything that may be unclear when placing an order or concluding a purchasing agreement.