



EMC TEST SYSTEM
for AUTOMOTIVE ELECTRONICS

KES SERIES



Transient Immunity Tester : **KES7700 Series**
Voltage Variation Simulator : **KES7400A Series**
Application Software for KES 7000 System : **KES7100**

KES7700 Series - Transient Immunity Tester



Transient Immunity Tester KES7700 Series are transient surge tester that utilizes a compact unit system. A surge generator circuit is installed for each pulse unit as the tester meets the requirement of ISO7637-2, ISO7637-3, ISO16750-2, JASO D001, SAE J1113, and other standards. The KES7700 Series meets a broad range of independent automobile manufacturer standards as well. The ISO7637 standard specifies Pulse 1, Pulse 2a, and Pulse 3a/3b, while the ISO16750-2 standard specifies Pulse 5a/5b. Each pulse simulates the following: electromagnetic phenomena produced by electronic equipment joined by wire harnesses during an automobile's normal operation, electromagnetic coupling during switch opening and closing, and load dump surges produced by the alternator when the battery is disconnected. Each pulse also tests the tolerance of on-board electronic equipment. In this testing, malfunctions and breakdowns involving on-board electronic equipment are evaluated.

■ **Full compliance with ISO 7637-2.2004, ISO 7637-2.2011, ISO 7637-3.2007, ISO 16750-2.2010**

■ **Load dump suppressor for pulse 5b**

The use of an amplifier circuit and a dedicated suppressor allows the system to generate waveforms that faithfully comply with the pertinent standards not only for pulse 5a required by ISO 7637 but also for pulse 5b.

■ **Compact modular cabinet**

The modular cabinet allows surge waveforms to be added with ease.

■ **Output terminals provided at a height of 50mm above the floor level as specified in the ISO 7637-2 standard**

Enhanced reproducibility

■ **Two types of CDNs available (60 V/50 A and 60 V/100 A)**

The main frame contains a built-in CDN module supporting up to 100 A, thereby allowing a large-capacity test to be conducted in a single cabinet without using any external CDN.

■ **Dedicated software for condition setting and tester control**

■ **JASO D001-94 pulse unit offered as an optional module**

For other details such as compliance with test requirements of individual auto makers, please contact us.

KES7702, KES7703 : Main Frame		
Item	Specification	
Model	KES7702	KES7703
CDN capacity	60 VDCmax 50 Amax	60 VDCmax 100 Amax
Input voltage	100 to 240 VAC (factory-set default*) 50/60 Hz 500 VA or less	
Dimensions	440(17.32")W x 405(15.94") H x 605(23.81") Dmm	440(17.32")W x 405(15.94") H x 620(24.40") Dmm
Weight	Approx. 45 kg(99.20lbs)	Approx.48 kg(105.82lbs)
PC interface	RS-232C	
Pulse module	Plug-in type: 5 modules (250 mm wide max.) External-connect type: 2 modules	
Others	Analog control terminal for the DC power supply for EUT, Monitor terminal (100:1), External stop terminal, Warning lamp terminal (24VDC, 500mA max), Emergency stop switch	

*Input voltage, 100, 110, 115, 120, 200, 220, 230, and 240 VAC available as factory option.

KES7721- Pulse2a



The KES7721 generate test pulses 2a required by the ISO and SAE standards. Test pulse 2a is used to simulate the transient phenomenon where induction occurs in the wire harness when the current flowing in the device connected in parallel to the tested device is suddenly cut off.

KES7721 : ISO7637-2 Pulse2a, ISO7637-3 Slow Pulses

Item	Specification
Model	KES7721
Pulse module 2a	Plug-in type
Peak voltage (Us)	±20 V to ± 300 V, in steps of 0.1 V
Output impedance (Ri)	2 Ω, 4 Ω, 10 Ω
Rise time (tr)	1 μs (+0 μs, -0.5 μs)
Pulse width (td)	50 μs ±10 μs at No Load, 40 μs ± 8.0 μs at 4 Ω Load, 12 μs ± 2.4 μs at 2 Ω Load
Repetition interval (t1)	0.2 s to 99 s, in steps of 0.1 s
DC cut time (t2)	1 ms to 100 ms, in steps of 0.1 ms
Surge delay time (t3)	Less than 100 μs
Driving power	Supplied from the main frame
Power consumption	-
Dimensions	50(1.96")W × 260(10.23")H × 330(12.99")D mm
Weight	Approx. 2.5 kg(5.51lbs)

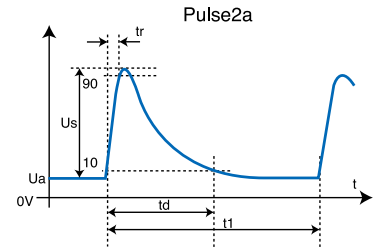

- Output impedance : Since 2Ω, 4Ω, and 10Ω can be selected, it supports ISO7637-2.2004SO standards and independent standards of automobile manufacturers.
- Since it also outputs negative polarity waveforms whose polarity has been reversed, it supports ISO7637-3.2007 standards and independent standards of automobile manufacturers.

KES7731- Pulse3a/3b



The KES7731 generate test pulses 3a/3b required by the ISO and SAE standards. Test pulses 3a/3b are used to simulate the transient phenomenon that occurs during the switching process.

KES7731 : ISO7637-2 Pulse3a/3b, ISO7637-3 Fast Pulses a & b

Item	Specification
Model	KES7731
Pulse module 3a/3b	Plug-in type
Peak voltage (Us)	±20 V to ± 300 V, in steps of 0.1 V
Output impedance (Ri)	50 Ω
Rise time (tr)	5 ns ±1.5 ns
Pulse width (td)	150 ns ±45 ns at No Load / 50 Ω Load
Repetition interval (t1) (Frequency)	1 to 100 kHz, in steps of 1 kHz
Generation time (t4)	10 ms
Pulse train interval (t5)	90 ms to 9.99 s, in steps of 0.1 ms
Driving power	Supplied from the main frame
Power consumption	-
Dimensions	50(1.96")W × 260(10.23")H × 330(12.99")D mm
Weight	Approx. 2.1 kg(4.62lbs)

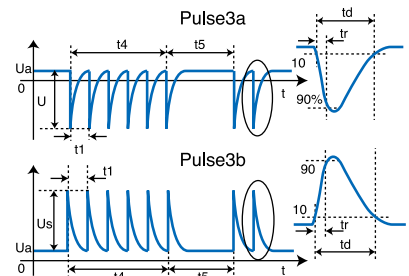

- Recurrence interval frequency sweeps (1 kHz to 100 kHz) can be performed. Four modes are available for sweeps.

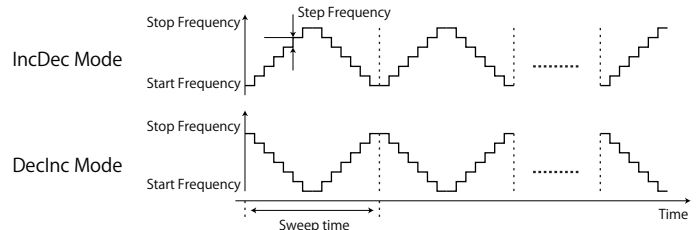
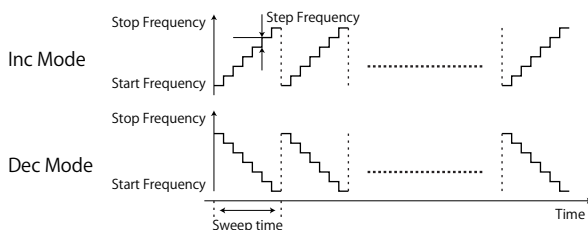

KES7750/7751- Pulse5a/5b



The KES7750, KES7751 generates test pulses 5a/5b required by the ISO and SAE standards. Test pulses 5a/5b are used to simulate the transient voltage that is produced when the battery is cut off from the operating alternator. An alternator having a transient voltage suppressor is tested with test pulse 5b, while test pulse 5a is used to test one that does not have such a suppressor.

KES7750, KES7751 : ISO7637-2.2004, ISO16750-2.2010 Pulse5a/5b		
Item	Specification	
Model	KES7750	KES7751
Pulse module 5a/5b	External-connect type	
Peak voltage (Us)	+40.0V to +200.0V(0.1 V step), +40.0V to +150.0V (Output impedance (Ri)=0.5Ω)	
Output impedance (Ri)	0.5Ω, 1Ω, 2Ω, 4Ω, 6Ω, 8Ω	
Rise time (tr)	10 ms (+0ms, -5ms)	
Pulse width (td)	Choose from 40ms, 50ms, 100ms, 150ms, 200ms, 250ms, 300ms, 350ms, 400ms, 450ms, 500ms, 550ms, 600ms, 650ms, 700ms	
Repetition interval (t1)	30.0 s to 99.0 s (0.1 s step) *Ua+Us ≥ 100V : 60.0 s to 99.0 s (0.1 s step)	
CDN capacity	60VDC max 50A max 60VDC max 100A max	
Driving power	Supplied from the main frame	
Power consumption	-	
Dimensions	440(17.32")W×280(11.02")H×595(23.42")D mm	440(17.32")W×280(11.02")H×610(24.01")D mm
Weight	Approx. 32 kg(70.54lbs)	Approx. 35 kg(77.16lbs)
ISO21848 Overvoltages(DC-10615 Load Dump)mode		
Peak voltage(Umax)	+40.0V to +120.0V (0.1 V step)	
Output impedance (Ri)	0.5Ω, 1Ω, 2Ω, 4Ω, 6Ω, 8Ω	
Rise time (tr)	10ms	
Control time(ts)	400ms	
Fall time (tr)	20ms	

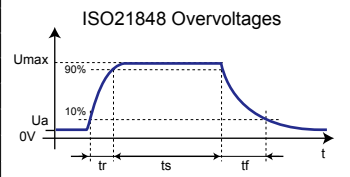
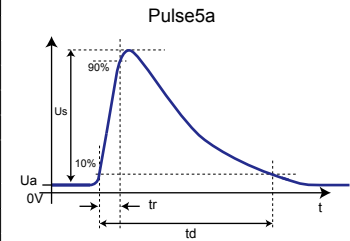

SPEC80677/80678- Pulse 5b Load Dump Suppressor

Complied with
ISO7637-2.2004
ISO16750-2.2010
Pulse5a/5b

The SPEC80677/80678 are suppressors that generates pulse 5b required by ISO 7637-2.2004, ISO16750-2.2010 standard. When connected with the pulse 5a/5b module (KES7750), it lets you set a suppressed voltage of up to 100 V in steps of 0.1 V.



Features

- Suppressed voltage: 100 V max. (settable in steps of 0.1 V)
 - The waveform required by the standard can be output accurately without changing the pulse width (td) that is set for pulse 5a.
- *The above applies only when Kikusui's pulse 5a/5b module (KES7750) or an amplifier circuit-based pulse 5a generator is used.

SPEC80677/80678 : ISO7637-2.2004, ISO16750-2.2010 Pulse5a/5b		
Item	Specification	
Model	SPEC80677	SPEC80678
Load dump suppressor for generating pulse 5b	External-connect type	
CDN capacity	60VDCmax 50Amax	60VDCmax 100Amax
Maximum input surge voltage (Us)	200 V Max	
Settable suppressed voltage range (Us')	10 to 100 V, in steps of 0.1 V / accuracy:3.0 V	
Maximum suction surge current	300A Max	
Maximum suction surge interval	30 s or more	
Driving power	100VAC to 240VAC 50/60Hz	
Power consumption	90VA or less	
Dimensions	440(17.32")W×133(5.23")H×550(21.65")D mm	
Weight	Approx. 17kg(37.47lbs)	

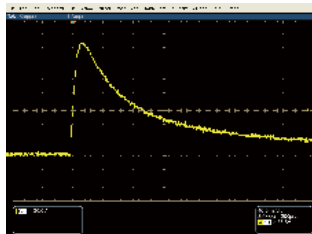
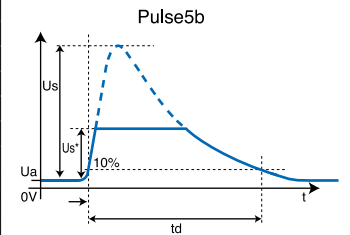

Pulse5a

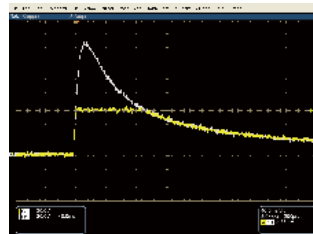

Pulse5b

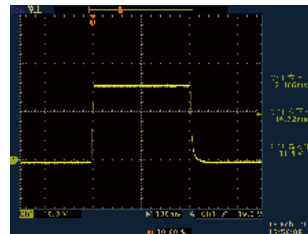

ISO21848 Overvoltages

Application Notes KES7700 Series

1. System components

The KES7702/KES7703 main frame can be connected with up to 7 pulse modules (5 plug-in type modules + 2 external-connect type modules). By replacing pulse modules, it is possible to comply with various automotive manufacturer's requirements, such as the ISO 7637-2 and JASO D001 standards.

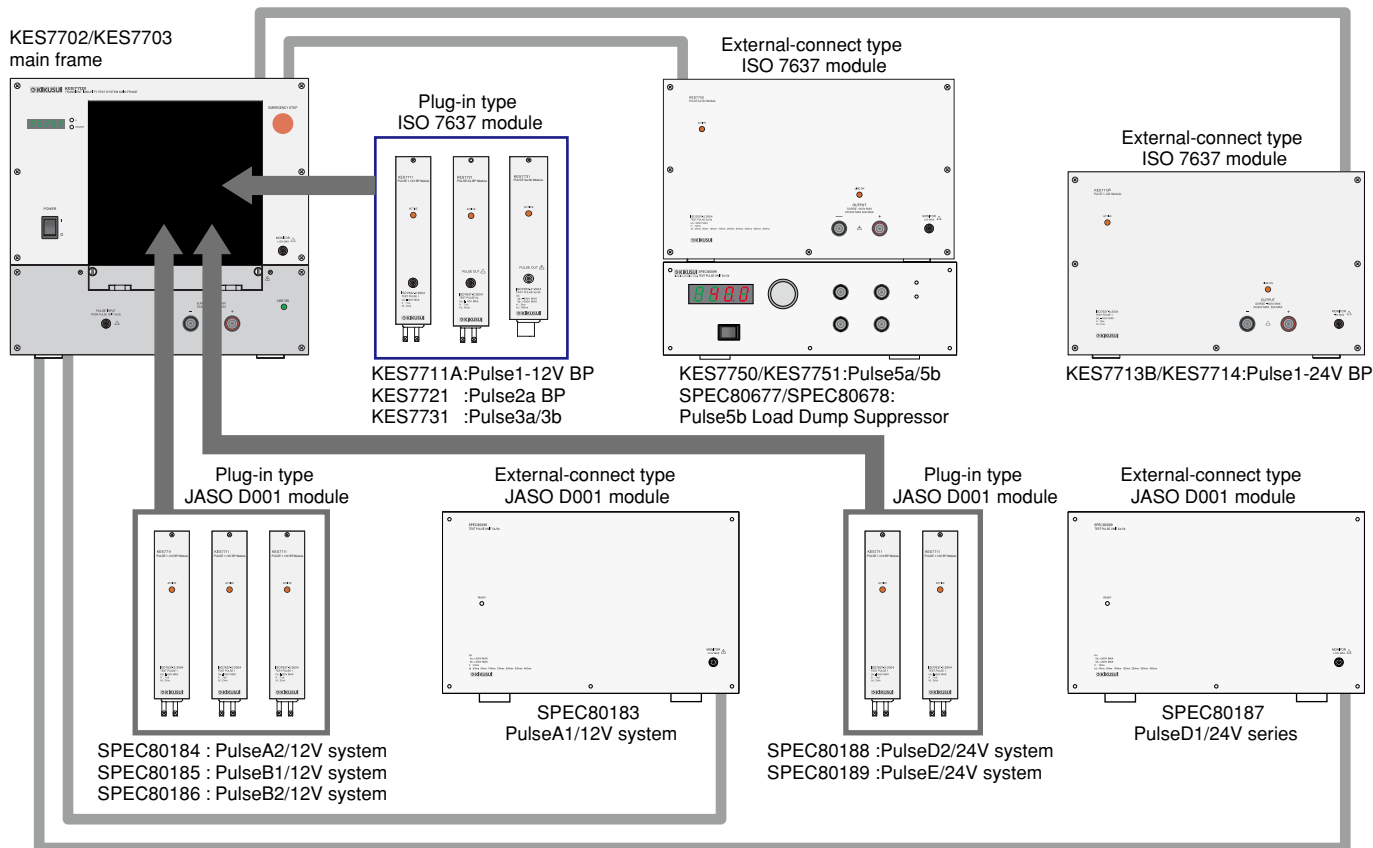

*In the KES7700 series, each pulse module supports a specific surge waveform. If the related international standard is revised, the system can be upgraded simply by replacing pulse modules. This system architecture also makes it easy to meet individual auto makers' test requirements.

2. Test reproducibility improvement

The KES7702/KES7703 mainframe are designed to simplify the setup of the test environment prescribed in the ISO7637-2 standards. Preparation of the test environment can lead to test reproducibility.

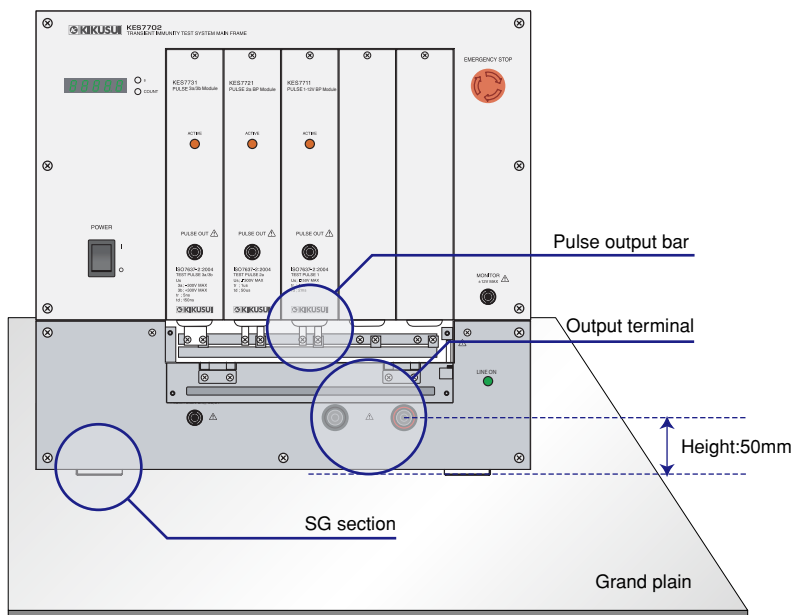

Output waveform stability

Placing the output system on the front surface and the power supply system and signal system on the rear surface made it possible to achieve stable transient surge output and communication control. Also, a bus bar was utilized for the output end. Since the input and communication control systems of each unit are separated from the output lines, malfunction of the tester itself due to transient surges being output is less likely to occur.

Test reproducibility

Since the lower part of mainframe KES7702/KES7703 testers is an SG unit, braided wire and other ground cables are unnecessary as a connection with a ground plane can be made. Also, the output terminal is set at a height of 50 mm from the ground plane (reference ground surface) as prescribed in the ISO7637-2 standards.

Options

SPEC80265A : R-UNIT for KES7721/KES7750/KES7751



Specification

Waveform observation resistor | 2 Ω (for Pulse2a,Pulse5a) | Input voltage: Maximum 200V

SPEC80266A : R-UNIT for KES7711A



Specification

Waveform observation resistor | 10Ω (for Pulse1-12V) | Input voltage: Maximum -100V

SPEC80267A : R-UNIT for KES7713B/KES7714



Specification

Waveform observation resistor | 50Ω (for Pulse1-24V) | Input voltage: Maximum -400V

SPEC80268A : Pulse Monitor UNIT for KES7700



Specification

Waveform observation adapter | No-load observation adapter | Input voltage: Maximum -900V to +400V

SPEC80488 : R-UNIT for KES7713B/KES7714



Specification

Waveform observation resistor | 20Ω (for SAE J1113-11 Pulse1b) | Input voltage: Maximum -400V

SPEC80617 : R-UNIT for KES7721



Specification

Waveform observation resistor | 4Ω (for Pulse 2a) | Input voltage: Maximum 200V

KES7300 : Capacitive Coupling Clamp



Specification

Compatible International Standard | ISO7637-3.2007(Second Edition)

Characteristic impedance | 50 Ω ± 10%

Coupling capacitance | 200pF or smaller

Maximum input voltage | ± 300V

Diameter that can be clamped | φ 40 mm max.

Connector shape | BNC connector

Weight | Approx. 5.5kg(12.12lbs)

Accessories | 20dB attenuator (30 W) × 1 [44-70-0010]

20dB attenuator (5 W) × 1 [97-03-0020]

Coaxial cable (500 mm) × 1 [89-04-1360]

SPEC80633 : DCC & ICC Cable Set



Specification

Compatible International Standard | ISO7637-3.2007(Second Edition)

Capacitor Box for DCC test | 100pF/220pF/470pF/0.1 μF *Maximum input voltage:150V

Joint Cable for DCC test | 30cm × 2, 100cm × 2

Ground Cable for DCC test | 50cm × 1, 100cm × 1

Cable for DCC test | BNC (P) -BNC (P) cable × 1 (40cm)

Connector for DCC test | BNC (P) -BNC (P) Connector × 1

for ICC test | BNC (P) -N (P) cable × 2 (45cm)

JASO D001-94

List of JASO D001-94 standard-compliant pulse un

JASO standards are automotive standards established by the Society of Automotive Engineers of Japan. For environment tests, "D001: General Rules of Environmental Testing Methods for Automotive Electronic Equipment" is most generally utilized. Pulse units for performing "transient voltage characteristics tests" in this standard are available as an option. This pulse unit can perform tests conforming to JASO D001 standards by connecting to mainframe KES7702/KES7703 testers.



■ Replacing a pulse unit makes it easy to comply with JASO standards. ■ Recurrence interval: Settings from a minimum of 5.0s are possible.
 ※Varies by pulse unit. Refer to the specifications shown below.

SPEC80183: JASO D001-94 Pulse A1/12V	
Specification	
Pulse module A1	External-connect type
Peak voltage(Us)/Damping constant/output resistance(R3)	+100V, in steps of 0.1 V/200mS/0.8Ω
Rise time (tr)	1μs or less
Repetition interval (t1)	30.0s~99s, in steps of 0.1s
Dimensions	440(17.32")W × 280(11.02")H × 580(22.83")D mm
Weight	Approx. 30kg(66.13lbs)
SPEC80184: JASO D001-94 Pulse A2/24V	
Specification	
Pulse module A2	Plug-in type
Peak voltage(Us)/Damping constant/output resistance(R3)	+150V, in steps of 0.1 V/2.5μs/0.4Ω
Rise time (tr)	1μs or less
Repetition interval (t1)	5.0s~99s, in steps of 0.1s
Dimensions	50(1.96")W × 260(10.23")H × 330(12.99")D mm
Weight	Approx. 3kg(6.61lbs)
SPEC80185: JASO D001-94 Pulse B1/B12V	
Specification	
Pulse module B1	Plug-in type
Peak voltage(Us)/Damping constant/output resistance(R3)/DC cut time	-100V, in steps of 0.1 V/60ms/8Ω/300ms
Rise time (tr)	1μs or less
Repetition interval (t1)	10.0s~99s, in steps of 0.1s
Dimensions	50(1.96")W × 260(10.23")H × 330(12.99")D mm
Weight	Approx. 3.5kg(7.71lbs)
SPEC80186: JASO D001-94 Pulse B2/B12V	
Specification	
Pulse module B2	Plug-in type
Peak voltage(Us)/Damping constant/output resistance(R3)/DC cut time	-290V, in steps of 0.1 V/2ms/80Ω/10ms
Rise time (tr)	1μs or less
Repetition interval (t1)	5.0s~99s, in steps of 0.1s
Dimensions	50(1.96")W × 260(10.23")H × 330(12.99")D mm
Weight	Approx. 2.5kg(5.51lbs)
SPEC80187: JASO D001-94 Pulse D1/24V	
Specification	
Pulse module D1	External-connect type
Peak voltage(Us)/Damping constant/output resistance(R3)	+150V, in steps of 0.1 V/400ms/1.5Ω
Rise time (tr)	1μs or less
Repetition interval (t1)	30.0s~99s, in steps of 0.1s
Dimensions	440(17.32")W × 280(11.02")H × 580(22.83")D mm
Weight	Approx. 30kg(66.13lbs)
SPEC80188: JASO D001-94 Pulse D2/24V	
Specification	
Pulse module D2	Plug-in type
Peak voltage(Us)/Damping constant/output resistance(R3)	+200V, in steps of 0.1 V/2.5μs/0.9Ω
Rise time (tr)	1μs or less
Repetition interval (t1)	5.0s~99s, in steps of 0.1s
Dimensions	50(1.96")W × 260(10.23")H × 330(12.99")D mm
Weight	Approx. 2.5kg(5.51lbs)
SPEC80189: JASO D001-94 Pulse E/24V	
Specification	
Pulse module E	Plug-in type
Peak voltage(Us)/Damping constant/output resistance(R3)/DC cut time	-340V, in steps of 0.1 V/26ms/210Ω/130ms
Rise time (tr)	1μs or less
Repetition interval (t1)	30.0s~99s, in steps of 0.1s
Dimensions	50(1.96")W × 260(10.23")H × 330(12.99")D mm
Weight	Approx. 3.5kg(7.71lbs)

KES7400A Series - Voltage Variation Simulator

The voltage variation simulator KES7400A series comes in a single cabinet that consists of a Signal Generator (SG) module (including an arbitrary pulse generator), which combines Kikusui Electronics Corp.'s power supply technology and EMC technology, and a high-speed bipolar power supply module. Many automotive electronic devices have long wire harnesses and inductive load characteristics, as do motors, or capacitive load characteristics with a large-capacity capacitor connected between the input and ground. In the case of these devices, general DC power supplies exceed the linear operation range, potentially making it impossible to obtain the desired waveform output. Considering this problem, it is common to use a bipolar power supply for automotive EMC testing.



In order to generate the reproduction of variation occurrence used by the actual automobile, the synchronized output is also possible up to 4ch such as ACC, IG1(or IG2), and ILL besides the connection to the +B (Battery line)

■ Complied to ISO7637-2.2004

The tester is capable of catering to individual auto makers' test requirements (except for extremely rare ones).

■ Bipolar power supply supporting a maximum range of ±60 V at ±50 A

Four models are available with power capacities of 12.5, 25.0, 37.5, and 50.0 A, respectively. 100 A or 200 A power supply can be offered on request.

■ Synchronized operation error: 1µs or less

■ The frequency response is 100 kHz (full voltage swing of ±60 V, no load)

■ The main unit of the power supply contains an arbitrary pulse generator. * Application software KES7100 is required.

Because there is an arbitrary waveform generator installed inside the main unit, there is no complicated wiring and little test preparation time required.

■ The tester can have a switch module built-in (factory option).

ISO 7637-2 Pulse 2b

Specification	
Peak current (Us)	60 V max. (±10%), in steps of 0.1 V *1
Pulse width (td)	200 to 2000 ms (±10% ±1 ms), in steps of 1 ms *
Supply voltage fall time (t12)	1ms (±50%) *1
Pulse rise time (tr)	1ms (±50%) *1
Pulse generation delay time (t6)	1ms (±50%) *1
Output resistance	0.02 Ω or less *2
Others	The output waveform rises and falls in a linear manner. *1

*1 No load on the output terminal of the power supply

*2 Comparison between the resistance with no load on the output terminal and that with a load on the output terminal

* Application software KES7100 is required.

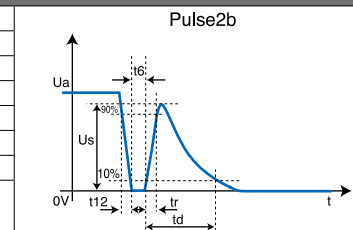

ISO 7637-2 Pulse 4

Specification	
Fall voltage (Ua)	60 V max. (±10%), in steps of 0.1 V *1
Fall voltage (Us)	60 V max. (±10%), in steps of 0.1 V *1
Constant voltage (UB)	60 V max. (±10%), in steps of 0.1 V *1
Fall time (t10)	1 to 100 ms (±10%), in steps of 1 ms *1
Rise time (t8, t11)	1 to 100 ms (±10%), in steps of 1 ms *1
Fall period (t7, t9)	1 to 100 ms (±10%), in steps of 1 ms *1
Output resistance	0.02 Ω or less *2
Others	The output waveform rises and falls in a linear manner. *1

*1 No load on the output terminal of the power supply (Vs > Va)

*2 Comparison between the resistance with no load on the output terminal and that with a load on the output terminal

* Application software KES7100 is required.

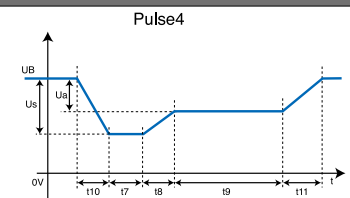

KES7400A Series Line Up

The KES7400A series enables Test Pulse 2b/Test Pulse 4 simulations and arbitrary waveform creations which are requirements of the ISO 7637-2:2004 standard. Test Pulse 2b is used to simulate the transient phenomenon that derives from the DC motor that serves as an engine after the ignition switch is turned off. Test Pulse 4 is used to simulate drops in the power supply voltage that occurs upon activation of the starter motor serving as the internal combustion engine. The arbitrary waveform generation function enables complex power supply voltage variation patterns to be created with ease. * Application software KES7100 is required.

KES7400A Series Pulse 2b, Pulse 4, Arbitrary

Item	Lineup			
	KES7400A (KES7410A) *1	KES7401A (KES7411A) *1	KES7402A (KES7412A) *1	KES7403A (KES7413A) *1
MODEL	KES7400A (KES7410A) *1	KES7401A (KES7411A) *1	KES7402A (KES7412A) *1	KES7403A (KES7413A) *1
	Output			
Output voltage/current	±60 V ±12.5 A	±60 V ±25 A	±60 V ±37.5 A	±60 V ±50 A
Peak current	±25 A (20 ms)	±50 A (20 ms)	±75 A (20 ms)	±100 A (20 ms)
Output mode	CV			
Frequency response	DC to 100 kHz: ±60V at no load, -3dB			
Small-amplitude frequency response (reference value)	DC to 300 kHz: ±10V at no load, -3dB			
Internal resistance	10mΩ or less			
Power/load variation	0.05% + 40 mV			
Ripple noise	40mVrms/100mVpp or less (at no load, factory-set default)			
Rise/fall time	1 μs or less (square wave 60 V)			
	Signal source (internal signal source)			
Built-in waveform (fixed)	ISO 7637 TEST PULSE 2b, TEST PULSE 4			
Built-in waveform (arbitrary)	Line, sine waveform, square waveform, sine sweep, square sweep, etc.			
Resolution (arbitrary)	Choose from 5 values, 100 μs, 1 ms, 10 ms, 100 ms, and 1000 ms.			
Frequency setting range (arbitrary)	1Hz to 500Hz			
Memory length (arbitrary)	16bit 64kword			
	Signal source (external signal input)			
Frequency range	DC to 300 kHz			
Gain	Up to 60 V of gain can be controlled with × 6 (±10 V), × 12 (±6 V)voltage.			
Input impedance	10 kW or less			
	Others			
I/F	RS232C			
Monitor	Voltage monitor			
Synchronous operation error	±1 μs or less			
Driving power	AC200 V 50/60 Hz (single phase)			
Power consumption	2 kVA or less	4 kVA or less	6 kVA or less	8 kVA or less
Operating temperature range	+5°C to +35°C			
Operating humidity range	30% to 85%rh (dew condensation not allowed)			
Storage temperature range	0°C to +40°C			
Storage humidity range	30% to 85%rh (dew condensation not allowed)			
Dimensions	440(17.32")W×740(29.11")H ×610(24.01")D mm	440(17.32")W×1010(39.76")H ×610(24.01")D mm	440(17.32")W×1140(44.88")H ×610(24.01")D mm	440(17.32")W×1275(50.19")H ×610(24.01")D mm
Weight	Approx. 85 kg(187.39lbs)	Approx. 120 kg(264.55lbs)	Approx. 155 kg(341.71lbs)	Approx. 190 kg(418.87lbs)
Protection function	Overheat, overcurrent, and overvoltage protection functions are available.			
Emergency stop switch	A red mushroom-shaped button switch is provided.			

*1 Shown in parentheses is the name of the model including the optional switch module.

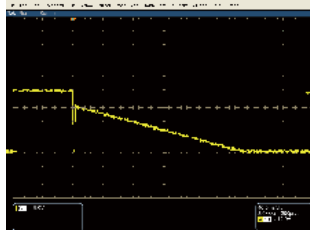

Pulse2b

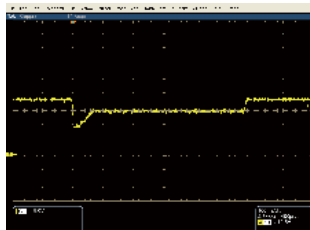

Pulse4

Application Notes KES7400A Series

1. System components

By making use of the KES7100 application software, KES7400A Series supply voltage variation testers can perform tests such as Test Pulse 4 and Test Pulse 2b, as required by ISO7637-2 standards, as well as supply voltage variation tests required individually by automobile manufacturers. A supply voltage variation waveform library has been prepared for the KES7100. Also, it is possible to edit the parameters that form the waveforms, such as voltage and variation time of waveform data. When the arbitrary waveform edit function is used, complicated supply voltage variation waveforms can easily be created as well. Moreover, when analog signals are input, the instrument can also be used as an amplifier. The model and number of units can be selected and the system configured in accordance with the specifications of the customer's test specimen.

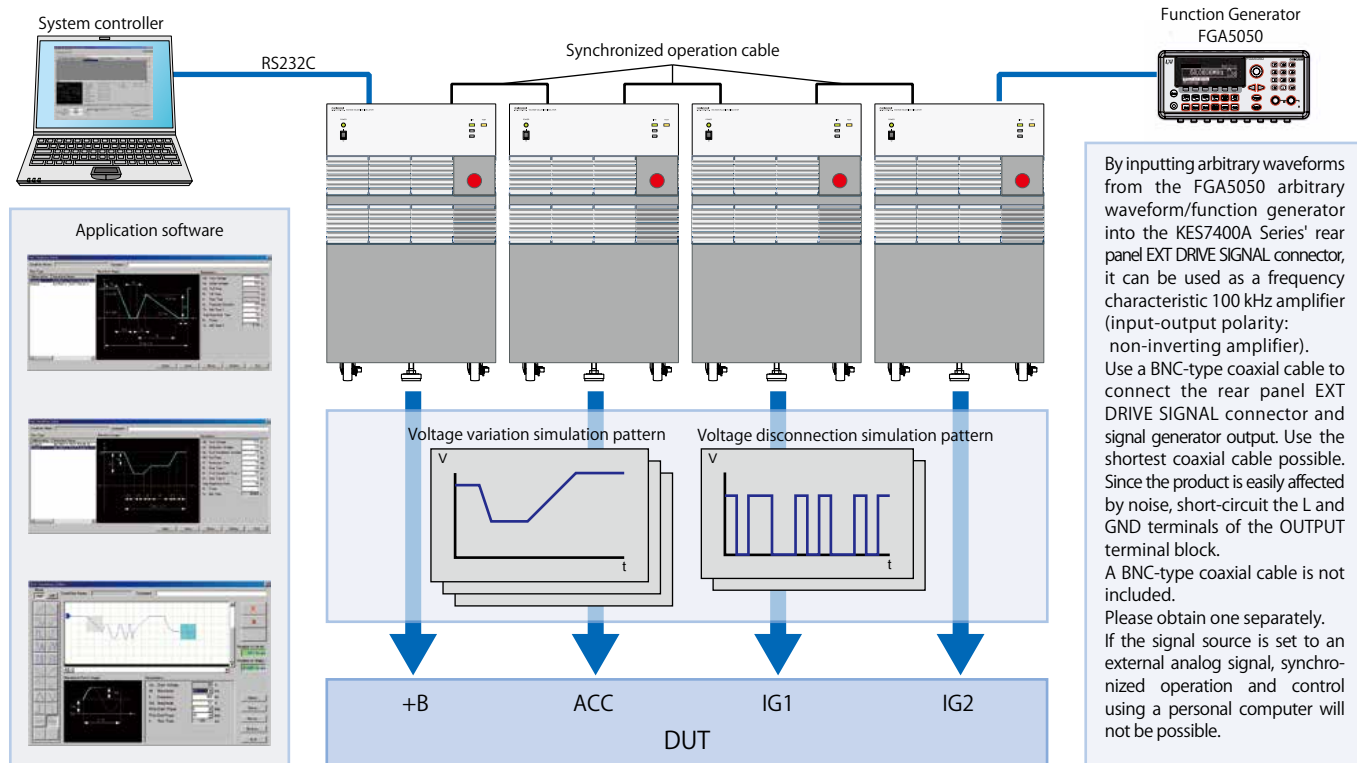

2. High-speed disconnection switch module

The KES7400A Series may contain a switch module that is available as a factory option. This switch module simulates an instantaneous power cut due to poor contact or other factor that may arise in an automotive electronic device connected to the wire harness. There are three disconnection modes that can be selected (anode mode, cathode mode, and two-electrode mode). Power can be disconnected by turning on or off either the anode (S1) or cathode (S2) switch or both.

[Conceptual diagram]

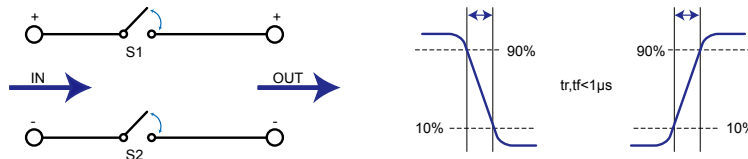

Item	Specification
Circuit disconnection switch	2 electrodes (anode and cathode)
Switch voltage and current	60 VDC max./The current value depends on the current capacity of the model in use.
Switch ON time	1 μs or less at 1kΩ load
Switch OFF time	1 μs or less at 1kΩ load
Disconnection modes	anode mode (S1) , cathode mode (S2) , two-electrode mode(S1 and S2 simultaneous)

[Overall waveform]

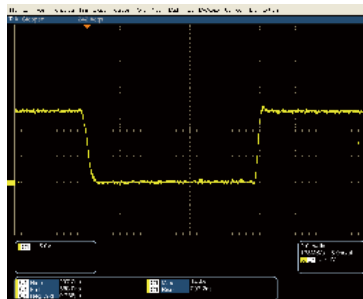

Measured value : Pulse width 9.74 μs

[Falling waveform]

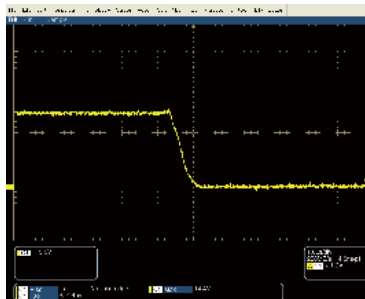

Measured value : Fall time 0.61 μs

[Rising waveform]

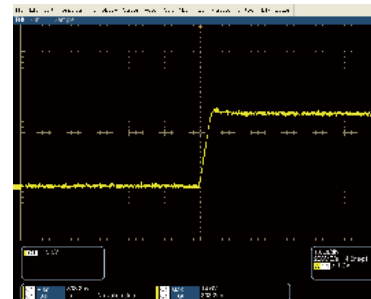

Measured value : Rise time 0.31 μs

Application Notes KES7400A Series

5.KES7400A series data

① Gain characteristics

Broadband gain characteristics (sine wave) with no load $\pm 60V$ swing

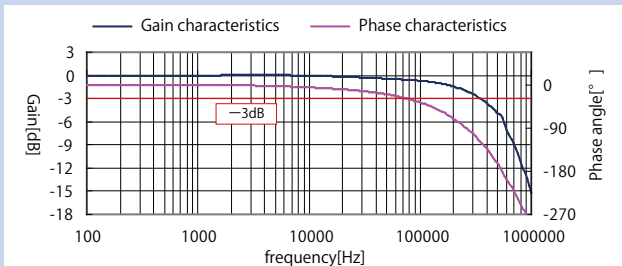

Broadband gain characteristics (sine wave) with no load $\pm 10V$ swing

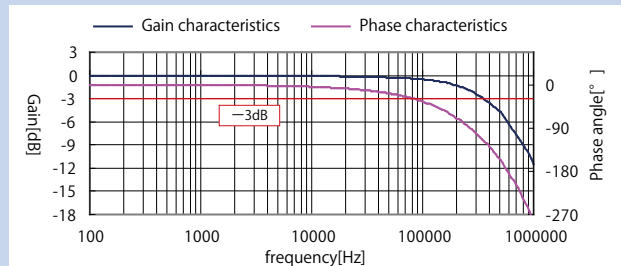

When there is no load $\pm 60V$ swing and $\pm 10V$ swing, almost flat gain characteristics are shown up to 100 kHz. The frequency at -3 dB also reaches 300 kHz. The linearity of gain characteristics within the specifications range is related to test reproducibility and compliance with the standards of automobile manufacturers.

② Impedance characteristics

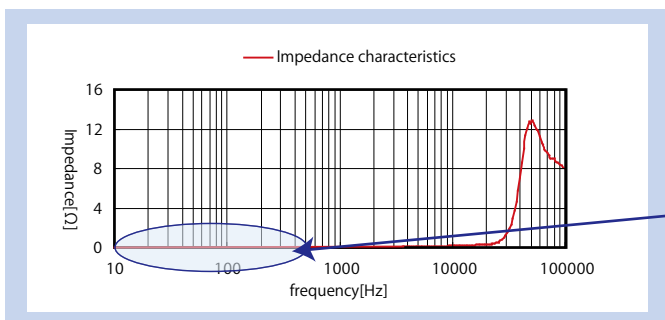

According to ISO7637-2 standards, the internal impedance of the power supply used in testing is specified as "10 mΩ or less" at DC - 400 Hz. The same standard also specifies "0Ω to 0.05 Ω" with Pulse 2b and "0Ω to 0.02 Ω" with Pulse 4.

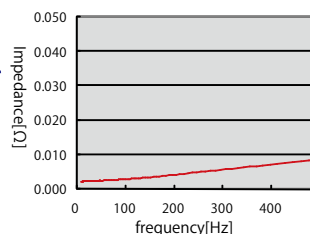

3 mΩ or less at DC - 400 Hz.

③ Rise/fall time: 1 μs or less

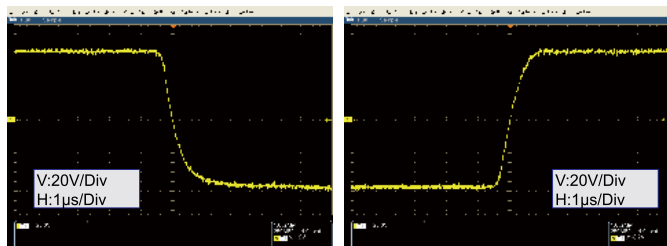

Actual waveform: +60V \Rightarrow -60V

Actual waveform: -60V \Rightarrow +60V

The response speed with a rise/fall time of "1 μs or less" will conform to tests such as momentary voltage drop tests and operation tests of relays required by each automobile manufacturer.

④ Power supply ripple noise: 100 mVp-p or less

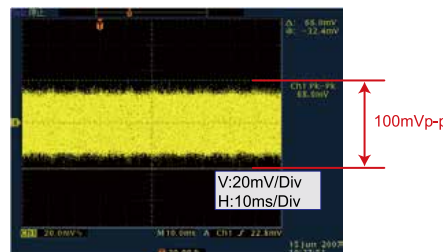

A power supply ripple noise of "100 mVp-p or less" will be compatible with minimal voltage step variability required by automobile manufacturers.

● Conditions of selecting the Voltage variation tester

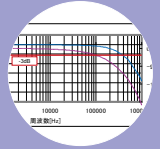

● Condition 1
Gain characteristics must be broad-ranged.

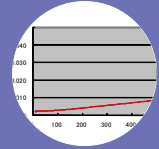

● Condition 2
Impedance characteristics must be low.

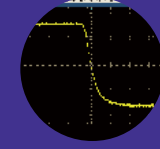

● Condition 3
Rise/fall time must be fast.

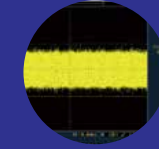

● Condition 4
Power supply ripple noise must be minimal.



● Condition 5
Testing with a waveform library must be simple.

← The supply voltage variation tester that meets these conditions is the "KES7400A Series." →

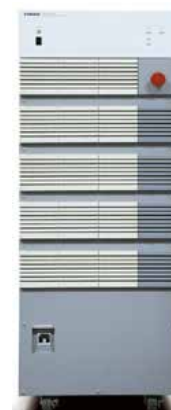

■ KES7100 Transient Surge Test

This waveform library is for transient surge testing. By default, it contains the waveforms specified by the ISO 7637-2 and JASO D001 standards.

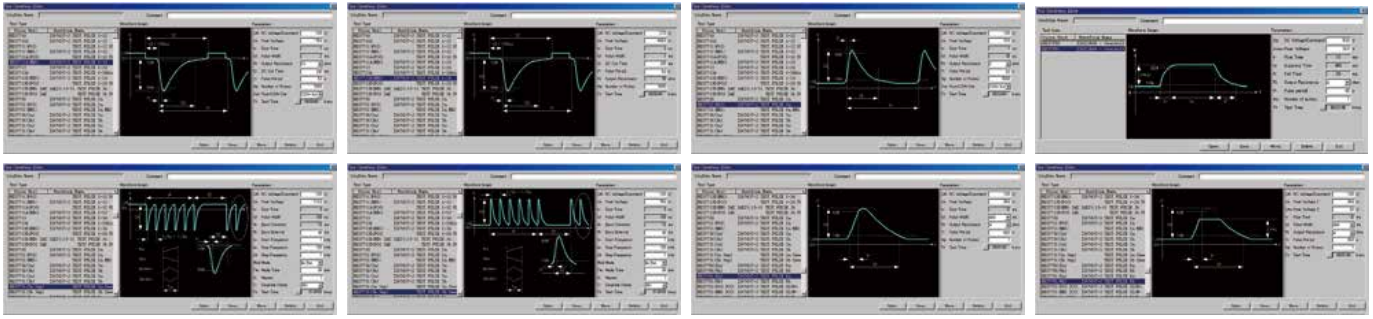

■ KES7100 Voltage Variations Test

This waveform library is for voltage variations testing. By default, it contains the Pulse 2b and Pulse 4 waveforms specified by the ISO 7637-2 standard.

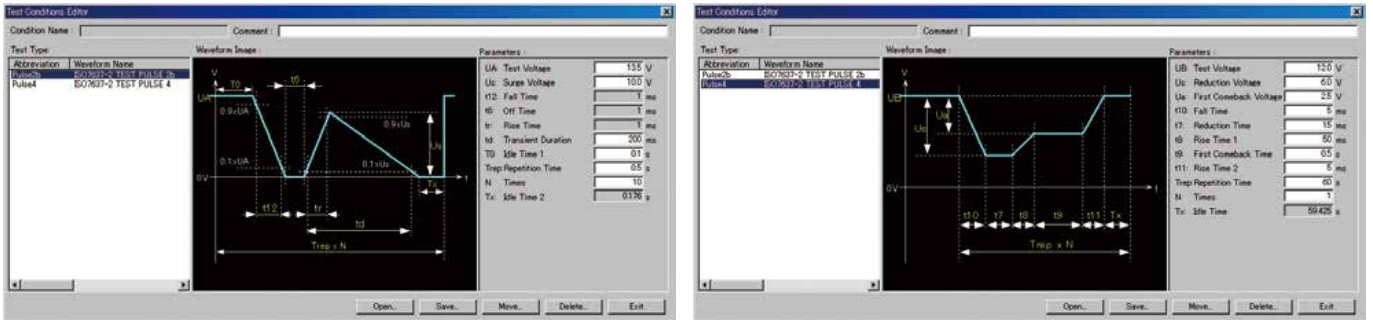

■ KES7100 Arbitrary Waveform Generation Function

A variety of waveforms can be generated by combining waveform parts.

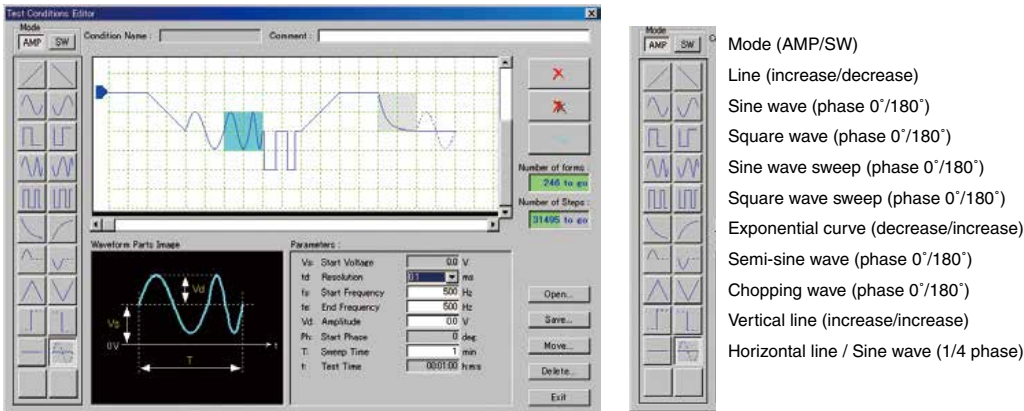

■ KES7100 Auto Maker-Specific Waveform Library (Example)

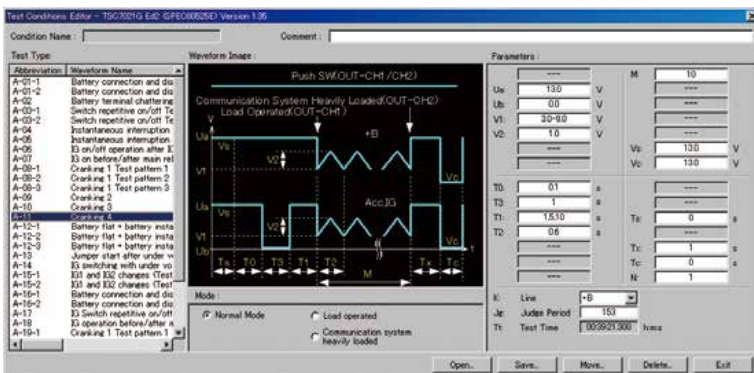

For voltage variation waveforms required by auto makers, pattern libraries are available (charged). Complex requirements like the values of V (voltage) and T (variable time) are varied in steps can be optionally added. (An estimate is to be made through consultation.)



KIKUSUI ELECTRONICS CORPORATION

1-1-3, Higashiyamata, Tsuzuki-ku, Yokohama, 224-0023, Japan
Phone: (+81) 45-593-7570, Facsimile: (+81) 45-593-7571, www.kikusui.co.jp

KIKUSUI AMERICA, INC. 1-877-876-2807 | www.kikusuiamerica.com



2975 Bowers Avenue, Suite 307, Santa Clara, CA 95051
Phone : 408-980-9433 Facsimile : 408-980-9409

KIKUSUI TRADING (SHANGHAI) Co., Ltd. | www.kikusui.cn



Room 216, Building 4, No.641, Tianshan Road, Shanghai City, China
Phone : 021-5887-9067 Facsimile : 021-5887-9069

For our local sales distributors and representatives, please refer to "sales network" of our website.

●Distributor:

■ All products contained in this catalogue are equipment and devices that are premised on use under the supervision of qualified personnel, and are not designed or produced for home-use or use by general consumers. ■ Specifications, design and so forth are subject to change without prior notice to improve the quality. ■ Product names and prices are subject to change and production may be discontinued when necessary. ■ Product names, company names and brand names contained in this catalogue represent the respective registered trade name or trade mark. ■ Colors, textures and so forth of photographs shown in this catalogue may differ from actual products due to a limited fidelity in printing. ■ Although every effort has been made to provide the information as accurate as possible for this catalogue, certain details have unavoidably been omitted due to limitations in space. ■ If you find any misprints or errors in this catalogue, it would be appreciated if you would inform us. ■ Please contact our distributors to confirm specifications, price, accessories or anything that may be unclear when placing an order or concluding a purchasing agreement.